

INFLUENZA COMPLEMENT-FIXATION. A SIMPLE QUANTITATIVE MICRO-METHOD

By G. BELYAVIN

*Department of Bacteriology, University College Hospital Medical School,
London, W.C.1*

(With 7 Figures in the Text)

The complement-fixation technique described in this paper was designed as a simple and rapid micro-method. It is derived from the method published by Fulton & Dumbell (1949), but a number of modifications have rendered it less laborious to perform and more flexible in application. Using rabbit, human and guinea-pig antisera, this technique has been successfully applied to the serological examination of the viruses of influenza, vaccinia and Newcastle disease, and experience with other materials, such as gonococcal antigen and extracts of chorio-allantoic membrane and mouse lung, suggests that it is of general application.

APPARATUS REAGENTS

Plastic sheets

The test is carried out on sheets of cream-coloured opaque resin plastic, $\frac{1}{8}$ in. thick, measuring $14 \times 12\frac{1}{4}$ in. These are ruled with a lead pencil into 156 1 in. squares.

Immediately before and immediately after use, the sheets are washed in a stream of distilled water and dried with blotting-paper. When not in use they are stored interleaved with thick filter-paper or blotting-paper. After a time drops may show a tendency to excessive spreading, but this can be eliminated by rubbing the surface vigorously with non-absorbent wool soaked in ether, followed by a rinse in 96 % methylated spirits and then in distilled water.

Dropping pipettes

Test volumes are measured with standard dropping pipettes delivering 20 cu.mm. of fluid per drop as described by Miles & Misra (1938). As each pipette is used it is discarded into 1 % formol-saline. When the experiment is complete, all the pipettes are removed from the discard vessel and rinsed immediately in cold running tap water, followed by a rinse in distilled water. They are then boiled for about 10 min. and dried in a hot air oven. In this way they are excluded from contact with acid, alkaline or oxidizing substances.

Dropping reservoir

Volumes of diluent for the serial dilution of antigens and antisera are obtained from a reservoir through a standard dropping pipette (Fig. 1). The rate of dropping

can be adjusted by a variable air inlet to the reservoir, and volumes of 0.2–0.6 ml. can be quickly delivered by counting the appropriate number of drops. Serial twofold dilutions of antigen and antiserum are carried out in these volumes by means of standard dropping pipettes, but when large bulk volumes are involved ordinary 1 or 5 ml. serological pipettes are used.

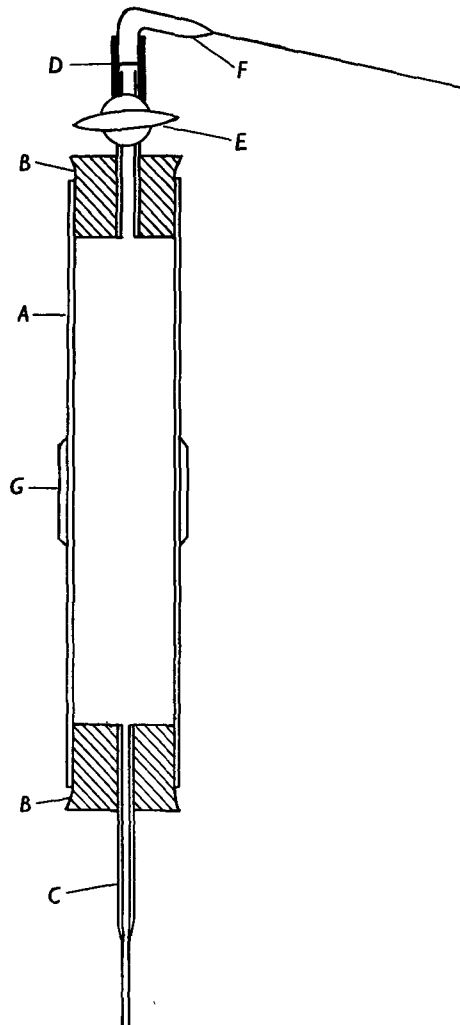

Fig. 1. *A*, glass reservoir; *B*, rubber bungs; *C*, 50-dropper pipette; *D*, rubber tubing; *E*, glass stop-cock; *F*, glass tube drawn out into a capillary; *G*, clamp.

Diluent

M/100-borate buffer saline (pH 7.6) was adopted as the standard diluent, but the complement-fixing antigens of certain virus strains such as Newcastle disease are not stable in the presence of borate ions, and in these cases M/150-phosphate buffer saline is the diluent of choice.

Haemolytic system

A 0.4% suspension by volume of thrice-washed sheep cells is prepared in borate buffer saline and standardized on a photo-electric densitometer (Belyavin, Westwood, Please & Smith, 1951). An equal volume of amboceptor containing between 8 and 16 M.H.D. per ml. is added for sensitization 2 min. before use. The sheep cells are stored in Alsever's solution as recommended by Fulton & Dumbell (1949).

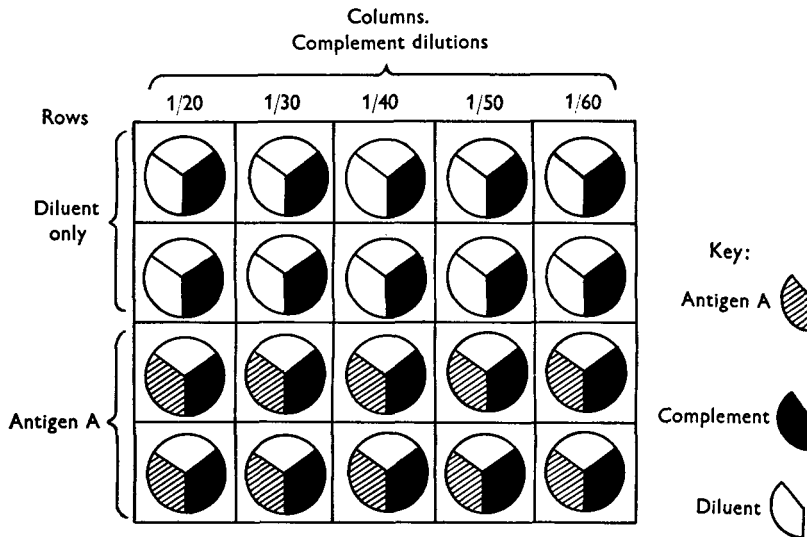

Fig. 2. Diagrammatic representation of plastic sheet showing a complement titration. The adjoining key indicates the composition of the test-drops.

Complement

Guinea-pig blood is obtained by cardiac puncture, the serum drawn off as soon as possible and sealed in small tubes in 0.5 ml. amounts. The contents are rapidly frozen by immersion in ice-salt mixture and then stored in the frozen state at -20°C . Under these conditions the serum has been found to maintain its complement activity for several months.

TECHNIQUE OF THE TEST

Complement titration

Duplicate complement titrations are carried out in plain diluent and in the presence of the maximum concentration of antigen to be used in the test. Test volumes of diluent, antigen and complement dilution respectively are distributed on a plastic sheet as illustrated in Fig. 2.

To make the serial dilutions of complement required, drops of diluent are first distributed from the reservoir into $3 \times \frac{3}{8}$ in. tubes and drops of $\frac{1}{10}$ complement are added to give a dilution series in steps of ten, i.e. $\frac{1}{20}$, $\frac{1}{30}$, $\frac{1}{40}$, $\frac{1}{50}$, etc. (Table 1).

The complement dilutions are added, moving from the highest to the lowest dilution, with a single pipette. The sheet is then placed in the humidity box

containing air saturated with water vapour at 37° C., and is incubated therein for 1 hr. 15 min., which is the usual fixation time. On removal of the sheet, one drop of cells sensitized 2 min. previously is added to each complement mixture with a standard pipette. The sheet is then replaced in the humidity box for 30 min. To read the results of the test, the sheets are withdrawn and subjected to a circular rocking motion readily imparted by hand, although a special centripetal rocker has been devised for the purpose. All unhaemolysed cells collect rapidly in the

Table 1. *Diluent and complement volumes used in complement titration*

Volume of diluent {measured	10	10	12	16	20	24	28	24	27	30	33	36
Volume of 1/10 {in stand- complement	10	5	4	4	4	4	4	3	3	3	3	3
Resultant complement dilution	1/20	1/30	1/40	1/50	1/60	1/70	1/80	1/90	1/100	1/110	1/120	1/130

N.B. For the same volumes, 1/n complement will give an arithmetic series in steps of n.

centre of each drop in a small button, the process being complete within 1-3 min. Mixtures giving total haemolysis of cells can thus be readily distinguished. It has not been found easy to determine intermediate degrees of haemolysis, and a 100 % haemolysis end-point has been adopted, as it can be unequivocally distinguished by this technique.

The complement, once titrated, can be used from day to day in appropriate dilution without retitration, provided the same antigens and sheep cells are used throughout.

The test proper

Twofold dilutions of antiserum are distributed in vertical columns on the plastic sheet, one drop of serum dilution per square, and after the addition of one drop of complement dilution containing two haemolytic units to each, the antigen is added along the horizontal rows, also in twofold dilution steps. The result is a 'chessboard' titration, each serum dilution being mixed with each antigen dilution in turn. After the mixtures have been distributed the plastic sheets are incubated in the humidity box for 1½ hr., at the end of which time the haemolytic system is added. The test is read as before after a further 30 min. incubation.

INTERPRETATION OF RESULTS

Use of the 'chessboard' titration for potency measurements

Using the 'chessboard' complement-fixation technique described, it has been found that antigen-antibody mixtures giving detectable fixation are distributed over an area approximating to a rectangle or parallelogram in shape. The areas obtained in a number of tests are illustrated in Fig. 3. The size of the area is virtually the product of the antigen and antibody titres expressed in logarithmic units to the base 2, twofold dilution series being used. If a series of preparations are tested against the same serum, therefore, their antigenic potencies will be a function of the respective fixation areas, i.e.

$$\log_2 \text{antigen} \times \log_2 \text{antibody} = \text{fixation area.}$$

Then for the same serum:

$$\log_2 \text{antibody} = \text{constant},$$

and therefore:

$$\text{fixation area 1} = \log_2 \text{antigen 1} \times \text{constant},$$

$$\text{fixation area 2} = \log_2 \text{antigen 2} \times \text{constant},$$

$$\text{fixation area 3} = \log_2 \text{antigen 3} \times \text{constant}, \text{ etc.}$$

For a given serum, therefore, it appears that the area of fixation is proportional to the logarithm of the antigen concentration.

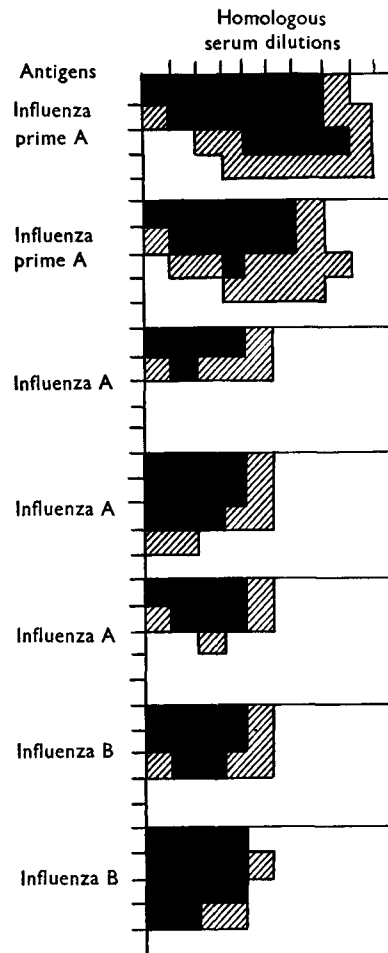

Fig. 3. Actual fixation areas obtained with influenza virus strains showing the approximation of the area to rectangular or parallelogram form. Black areas indicate mixtures giving total fixation against two haemolytic units of complement, and shaded areas, partial fixation. Each test mixture is represented by a square and not a point.

As an independent check on the validity of this generalization, it was assumed that for a given influenza virus strain, the haemagglutinin titre could be used as a function of complement-fixing potency. There is every reason to accept this as true (Fulton & Dumbell, 1949). Type A influenza virus antigen was prepared by

the differential centrifugation of an infected allantoic fluid with fivefold concentration of the virus. The haemagglutination titre of this material was estimated by a photo-electric titration method (Belyavin *et al.* 1951) and serial 1·2-fold dilutions were prepared, close dilution intervals being adopted in order to obtain

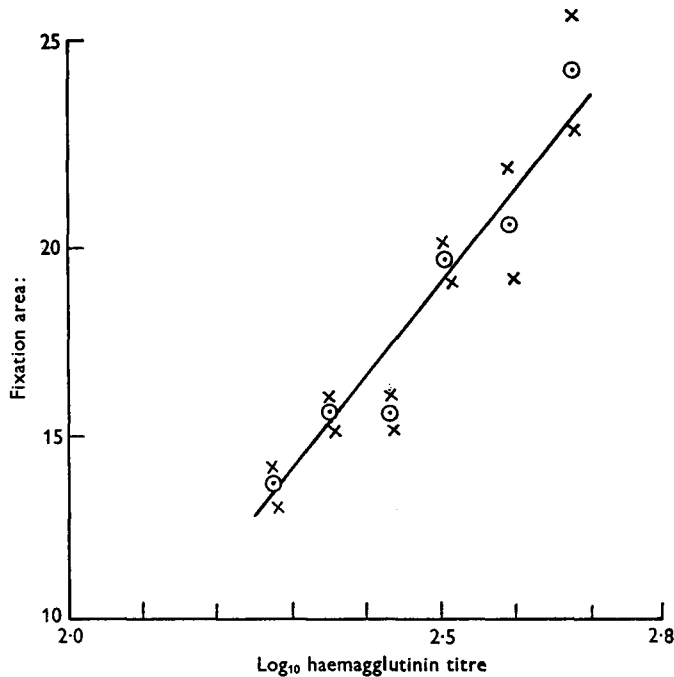

Fig. 4. Replicated complement-fixation tests with different concentrations of an influenza virus antigen (PR 8) against a specific rabbit serum, showing linear relationships of area of fixation to log antigen dose.

Table 2

Log ₁₀ HA titre (x)	Areas of fixation (y)		Mean area
	1	2	
2·67	26	23	24·5
2·59	22	19	20·5
2·51	20	19	19·5
2·43	15	16	15·5
2·35	16	15	15·5
2·27	13	14	13·5

Duplicate complement-fixation tests using 1·2-fold dilutions of an influenza virus antigen (PR 8) against a specific rabbit antiserum (complement dosage, 2 units).

at least six concentrations of virus within a reasonable range. Duplicate complement-fixation tests against a rabbit antiserum were carried out on each of these dilutions, only the serial antigen dilutions being replicated for each chessboard. The areas were measured by counting the number of squares (i.e. drops) showing fixation, and their means were plotted against the logarithm to the base 10 of the haemagglutinin titre (Fig. 4, Table 2). A linear regression of area on log₁₀ HA titre

was calculated, and an analysis of variance to test the goodness of fit carried out (Table 3). The fit of the linear regression is reasonably good as the residual variance based on titres, once that due to the regression is removed, does not differ significantly from the error variance. It may be concluded that the area of fixation is linearly related to the logarithm of the concentration of complement-fixing virus; the regression equation being of the form:

$$y = ax - b, \quad (1)$$

where y is the fixation area, x the \log_{10} of the haemagglutinin titre, and a and b are constants. If the fixation area is measured by suitable means it can be used, therefore, as an estimate of antigenic potency. Fulton & Dumbell (1949) have empirically adopted the same comparative method, using a constant antigen technique.

Table 3. *Analysis of variance of the data in Table 2 to test the linearity of the calculated regression of fixation area on \log_{10} haemagglutinin titre: $y = 24.8x - 43.05$*

Item	Sum of squares	Degrees of freedom	Mean square
Columns	3.0	1	3.0
Classes {	regression	1	156.4
	residue	4	2.65
Column/classes (error)	7.7	5	1.54
Totals	177.7	11	—

Sensitivity of influenza antigen detection

If log HA titre is plotted against fixation area for a series of influenza antigens, the resulting linear regression may be prolonged to cut the abscissa. This will give the minimum concentration of virus antigen expressed in agglutination units, which can be detected by complement fixation with a given antiserum. With the sera so far tested, complement fixation has not proved as sensitive as the haemagglutination test, for detecting small amounts of virus. Serum samples taken from the same rabbit during immunization with influenza antigen show variations of sensitivity in this respect (Fig. 5), and it is probable that this is to some extent a reflexion of the antibody level. Both the slope of the area/antigen dose regression line and the minimum detectable dose of antigen may differ between sera from different animals at the same stage of immunization and with similar antibody potencies (Fig. 6). This renders the comparison of antibody levels difficult by this method, although theoretically the antibody 'titre' should be measurable by the constant a in equation (1) (i.e. the slope of the regression line), for this determines the rate of change of fixation area per unit change in antigen concentration. The relationship

$$\text{fixation area} = \log_2 \text{antigen conc.} \times \log_2 \text{antibody conc.}$$

makes this clear.

It is interesting to note that the constant b (equation 1), which determines the height of the regression line above the abscissa, is an inverse function of the minimum antigen dose detectable with a given serum.

DISCUSSION

In spite of the convenient relationship between fixation area as defined, and antigen potency, some further justification must be made out for the use of area measurements as opposed to simple maximal or optimal antigen titres, 'chessboard' titrations always being more laborious than simple ones.

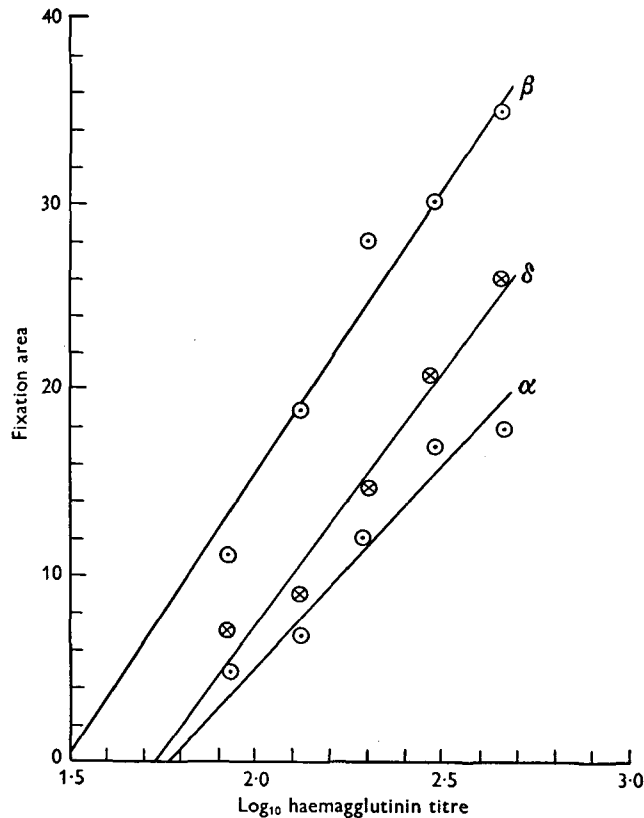

Fig. 5. Fixation area plotted against log antigen dose for successive serum bleeds from an influenza immune rabbit. α = serum bleed 21 days after 200 A.D.'s of influenza type A virus (PR8) intravenously. β = serum bleed 5 days after a second dose of 2000 A.D.'s of virus intravenously. δ = serum bleed taken 3 weeks after second dose of virus.

For a discussion of the objections to 'optimal titre' estimations, it is convenient to regard the fixation area as a simple rectangle, although in practice it may approximate to a parallelogram. In fact, the smallest concentration of both antigen and antibody, which when mixed together will give detectable fixation under the conditions of the test, determines the size of the fixation area (point X, Fig. 7).

This mixture will fall on the diagonal of the fixation area, and represents an optimally fixing proportion of antigen to antibody, in other words, that proportion which will fix the *greatest* amount of complement. Actually, the mixture may contain varying degrees of antigen or antibody excess, as it has been shown that maximal fixation of complement commonly occurs in either region according to

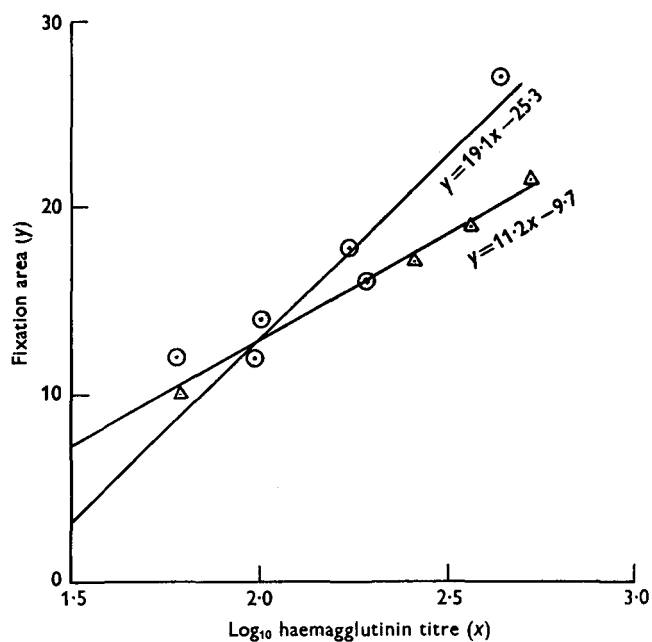

Fig. 6. Fixation area plotted against log antigen dose, for two sera derived from two different rabbits bled about a fortnight after a single intravenous dose of 300 A.D.'s of influenza virus (PR 8). Haemagglutinin inhibition titre of both sera about 2000. The slopes of the two lines differ significantly ($0.05 > P > 0.02$).

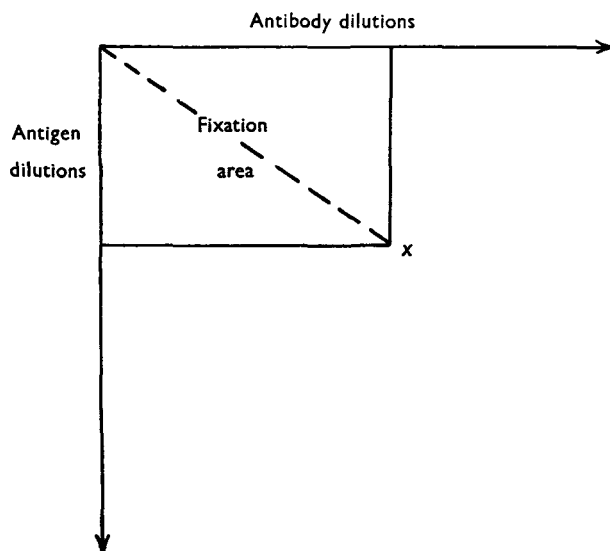

Fig. 7. Diagrammatic representation of fixation area indicating mixture containing smallest amounts of antibody and antigen capable of giving detectable fixation against a standard dose of complement (point X).

the antigen/antibody system used (Dean, 1912; Goldsworthy, 1928). The ratio of antigen to antibody in the mixture represented by the point X (Fig. 7) will be a function of the ratio \log_2 antibody to \log_2 antigen titres, i.e. the ratio of the sides of the rectangle. It follows that antigens of equal potency may give equal fixation areas, but different ratios of \log antibody/ \log antigen concentrations, according to whether maximal fixation with any one antigen occurs in region of greater or lesser excess of one reacting component. It has in fact been observed that influenza antigens of apparent equal potency, as judged by haemagglutination and giving equal fixation areas, may nevertheless give different maximal titres, and it is possible that the same phenomenon may play some part in the variation in sensitivity of sera in detecting influenza antigen.

Expenses of the work were partially defrayed by a departmental grant from the Medical Research Council. Thanks are due to Prof. Wilson Smith and to Dr J. C. N. Westwood for advice and criticism, and to Dr F. W. Sheffield for help with some of the tests.

REFERENCES

- BELYAVIN, G., WESTWOOD, J. C. N., PLEASE, N. & SMITH, W. (1951). *J. gen. Microbiol.* **5**, 546.
DEAN, H. R. (1912). *Z. Immunforsch.* **13**, 84.
FULTON, F. & DUMBELL, K. R. (1949). *J. gen. Microbiol.* **3**, 97.
GOLDSWORTHY, N. E. (1928). *J. Path. Bact.* **31**, 220.
MILES, A. A. & MISRA, S. S. (1938). *J. Hyg., Camb.*, **38**, 732.

(*MS. received for publication 16. IV. 53*)