

MRS Bulletin

July 2012 Vol. 37 No. 7
www.mrs.org/bulletin



MATERIALS RESEARCH SOCIETY
Advancing materials. Improving the quality of life.

Scanning probes for new energy materials: Probing local structure and function

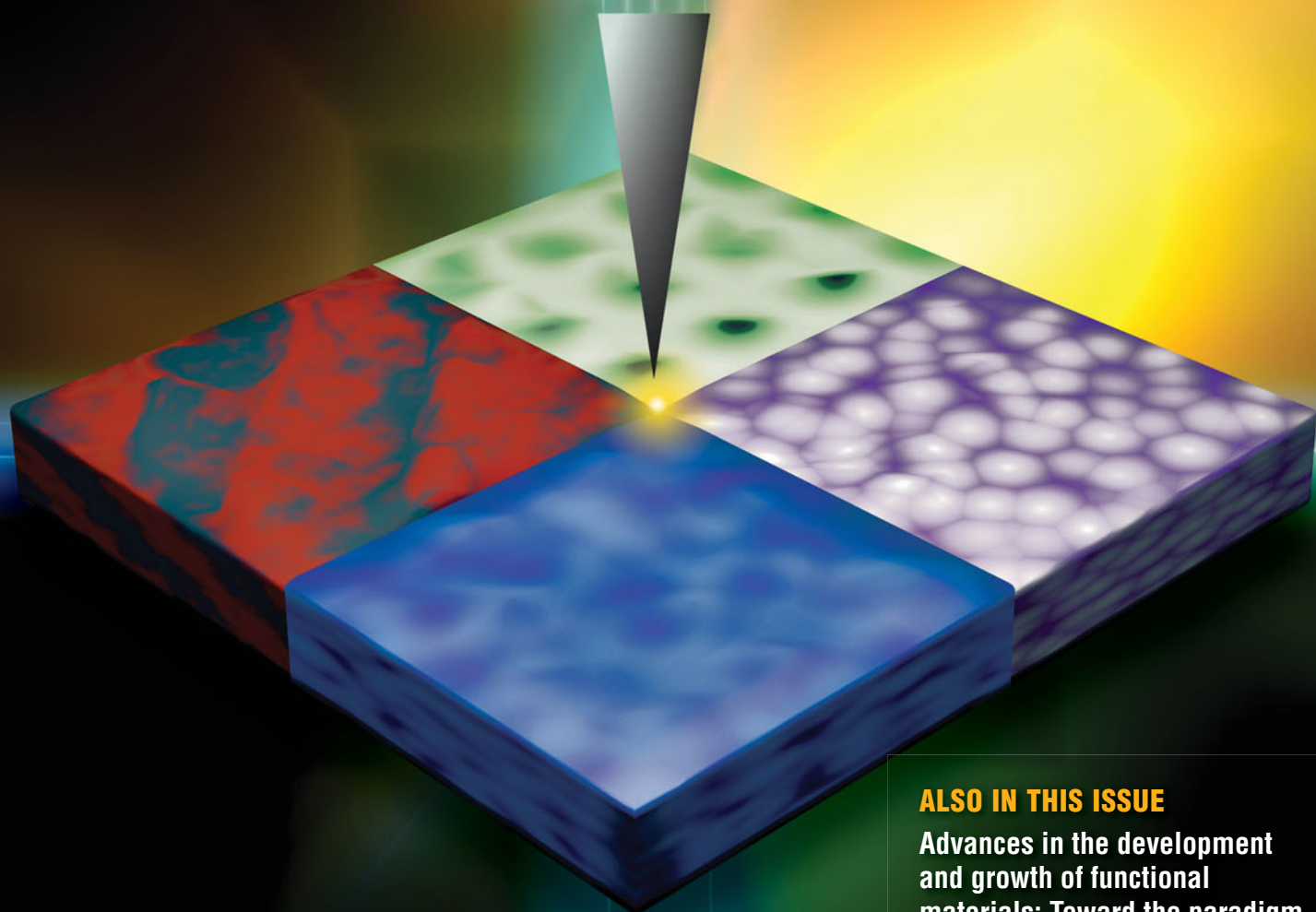

ALSO IN THIS ISSUE

Advances in the development and growth of functional materials: Toward the paradigm of materials by design

CAMBRIDGE
UNIVERSITY PRESS

CUSTOMIZED PRODUCTION ION IMPLANTERS

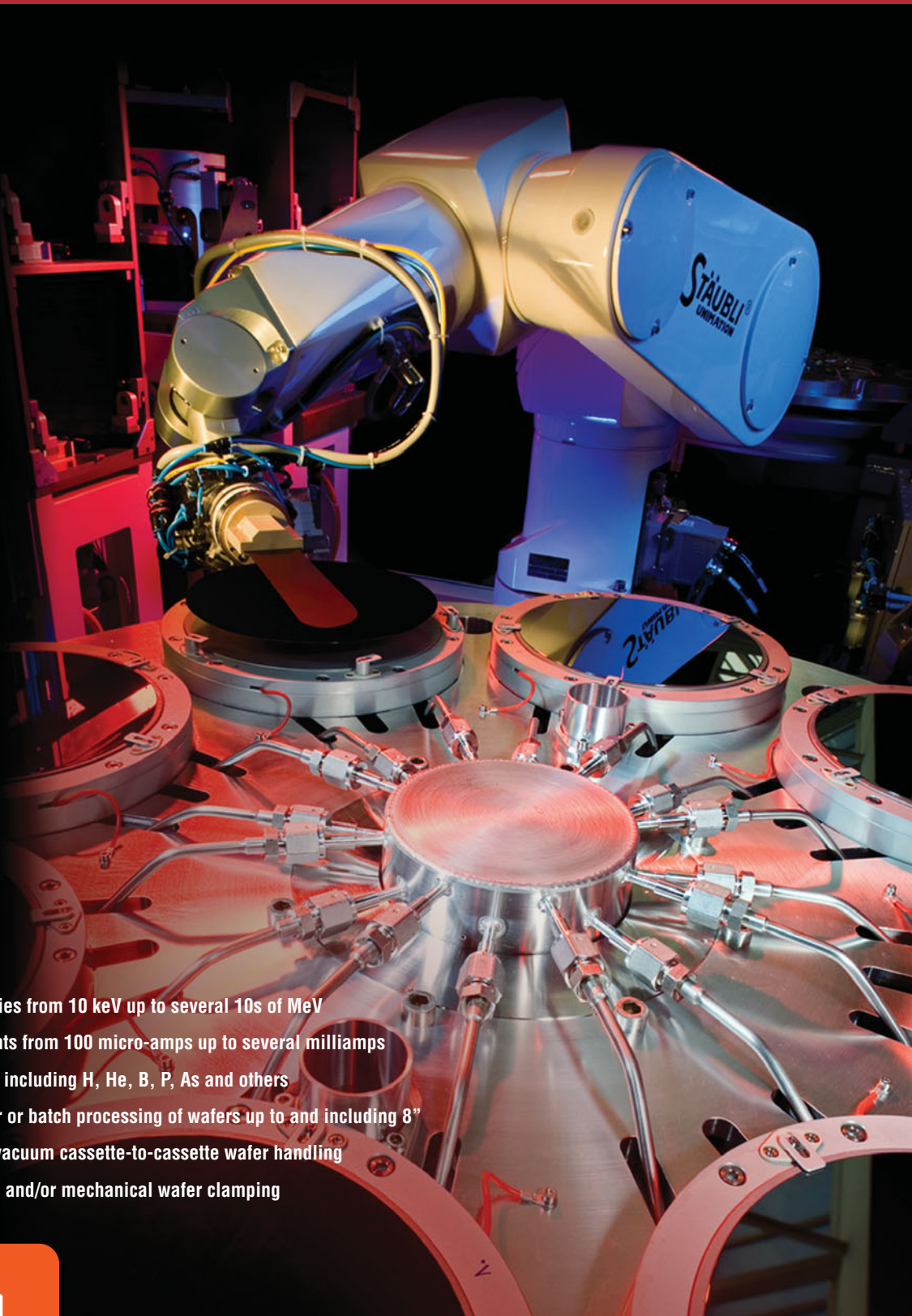

- Beam energies from 10 keV up to several 10s of MeV
- Beam currents from 100 micro-amps up to several milliamps
- Ion species, including H, He, B, P, As and others
- Single wafer or batch processing of wafers up to and including 8"
- In-air or in-vacuum cassette-to-cassette wafer handling
- Electrostatic and/or mechanical wafer clamping



High Voltage Engineering

High Voltage Engineering Europa B.V.

P.O. Box 99, 3800 AB Amersfoort, The Netherlands

Tel: 31 33 4619741 • info@highvolteng.com

www.highvolteng.com



NX10

Atomic Force Microscope

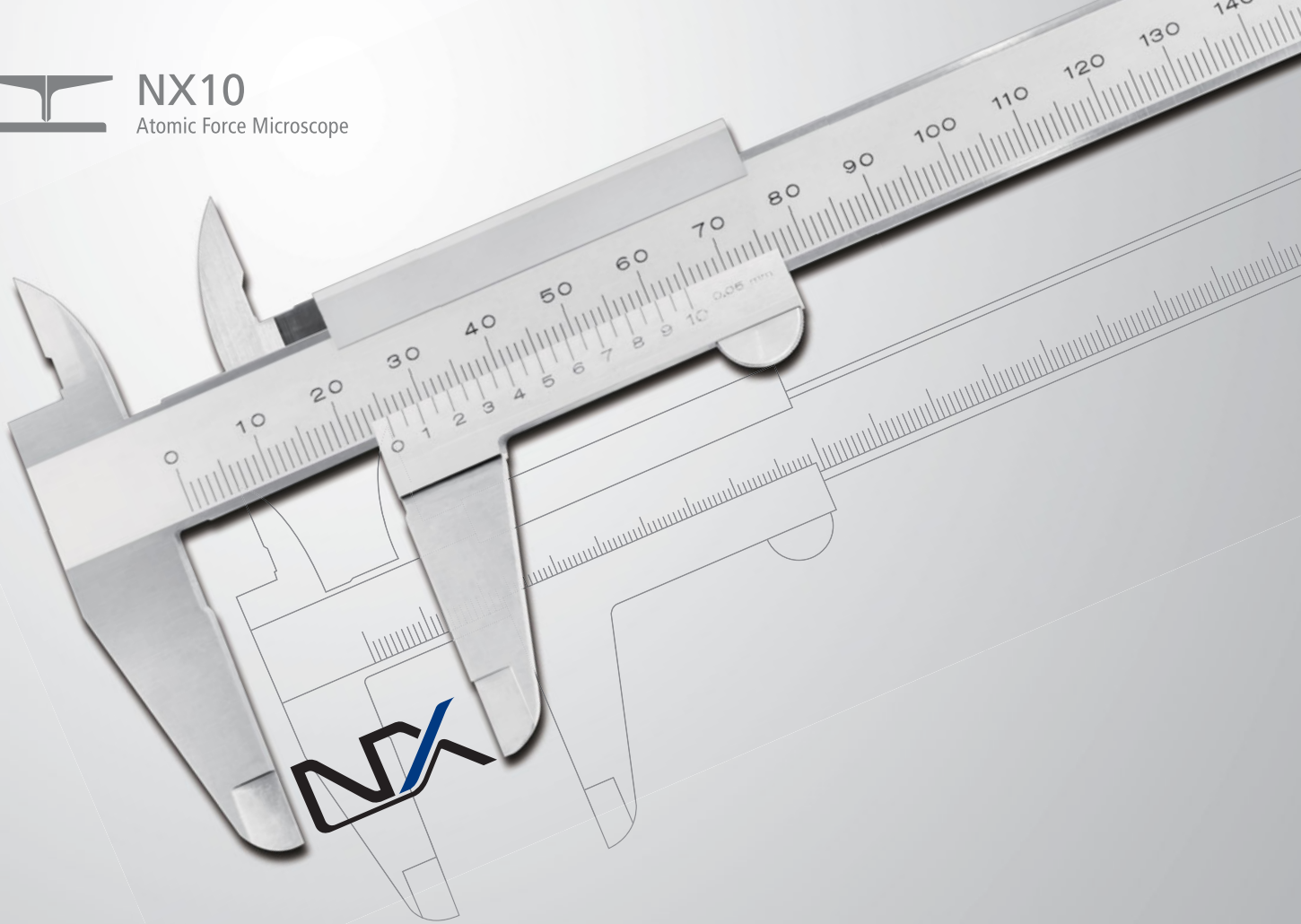

The World's Most **Accurate AFM**

Data accuracy is of paramount importance to nanotechnology researchers as the credibility of their research depends on it. The NX10, The World's Most **Accurate AFM**, is the flagship AFM (Atomic Force Microscope) of Park's new product line. Park NX10 brings unparalleled imaging accuracy, scan speed, and tip life to the next generation of researchers, all at an affordable price. The NX platform builds on Park's 28 years of technology leadership in AFM data accuracy, and its reputation as the leading nanotechnology solutions partner to research and industry.

Park NX10 features industry's only True Non-Contact AFM with industry-leading Z-servo speed, XYZ scanner linearity, closed-loop detector noise, and minimized thermal drift. Park NX10 is the world's premium research grade AFM that is user-friendly and convenient to use for new and experienced users alike. Please visit us at www.parkAFM.com/nx for more information.



THE ACCURATE CHOICE



Park
SYSTEMS

www.parkAFM.com



CONTENTS

SCANNING PROBES FOR NEW ENERGY MATERIALS: PROBING LOCAL STRUCTURE AND FUNCTION

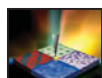

633 **Scanning probes for new energy materials:
Probing local structure and function**

Nina Balke, Dawn Bonnell, David S. Ginger, and
Martijn Kemerink, Guest Editors

638 **Meet Our Authors**

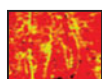

642 **Scanning probe microscopy of solar
cells: From inorganic thin films to organic
photovoltaics**

James R. O'Dea, Louisa M. Brown, Nikolas Hoepker,
John A. Marohn, and Sascha Sadewasser

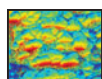

651 **Electrochemical strain microscopy: Probing
ionic and electrochemical phenomena in
solids at the nanometer level**

Stephen Jesse, Amit Kumar, Thomas M. Arruda,
Yunseok Kim, Sergei V. Kalinin, and Francesco Ciucci

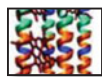

659 **Nanoscale impedance and complex properties
in energy-related systems**

Wonyoung Lee, Fritz B. Prinz, Xi Chen,
S. Nonnenmann, Dawn A. Bonnell,
and Ryan P. O'Hayre

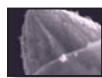

668 ***In situ* scanning electrochemical probe
microscopy for energy applications**

Stanley C.S. Lai, Julie V. Macpherson,
and Patrick R. Unwin

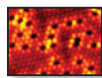

677 **The structure and reactivity of surfaces
revealed by scanning tunneling microscopy**

Flemming Besenbacher, Peter Thostrup,
and Miquel Salmeron

TECHNICAL FEATURE

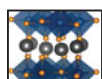

682 **Advances in the development and growth
of functional materials: Toward the paradigm
of materials by design**

Ram Seshadri, Stephanie L. Brock, Arthur Ramirez,
M.A. Subramanian, and Mark E. Thompson

DEPARTMENTS



OPINION

621 **Material Matters**

One researcher's impressions of Graphene 2012

Mildred S. Dresselhaus



NEWS & ANALYSIS

624 **Research/Researchers**

■ **Nanobubble plus chemotherapy equals single-cell
cancer targeting**

■ **Chemical doping helps break efficiency record
for graphene solar cells**
Tobias Lockwood

■ **Topological insulator Bi_2Se_3 opens path to room-
temperature spintronics**

■ **Colloidal quantum dot films show RGB lasing**
Rosalia Serna

■ **Mildred S. Dresselhaus receives
Kavli Nanoscience Prize**

628 **Science Policy**

■ **US generates new support for dealing
with "Big Data"**
Kendra Redmond

■ **EC releases practical guide to green products
and services**

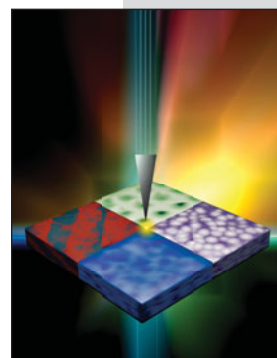

ON THE COVER

Scanning probes for new energy materials: Probing local structure and function. The first generation of scanning probe microscopy techniques are considered essential tools in materials characterization and are used routinely in basic and applied research and development, as discussed in the articles in this issue with a focus on energy-related materials. The cover shows four surface structures representative of property variations in energy materials, with each schematically illustrating aspects of a class of materials discussed in this issue. Top: periodic array of quantum dots or plasmonic particles, right: ionic conductor with grain boundaries, bottom: typical structure of polymer blends as in solar cells, left: ferroelectric domains. Image courtesy of Stephen Nonnenmann. See the technical theme that begins on page 633.



691 SOCIETY NEWS

- Brongersma, Matias, Segalman, Shea, and Watanabe to chair 2013 MRS Spring Meeting
- Highlights from the 2012 Materials Research Society Spring Meeting and Exhibit
- Preview: XXI International Materials Research Congress 2012
- Conference on combinatorial materials S&T to be held in October
- 7th Advanced Materials Science and Nanotechnology Symposium to be held December 2012
- Advanced materials and nanotechnologies discussed at YUCOMAT 2011



699 CAREER CENTRAL



FEATURES

- 630 **Beyond the Lab**
The Thiel Foundation's Breakout Labs program funds innovation
 Piper J. Klemm
- 698 **Books**
Mechanics of biomaterials: Fundamental principles for implant design
Lisa A. Pruitt and Ayyana M. Chakravartula
 Reviewed by Catherine Klapperich
- 703 **Postterminaries**
Science fiction fantasies
 Steve Moss

ADVERTISERS IN THIS ISSUE

Page No.

American Elements	Outside back cover
Asylum Research	Inside back cover
High Voltage Engineering	Inside front cover
HORIBA Scientific	632
JEOL USA, Inc.	623
Lake Shore Cryotronics, Inc.	637
MMR Technologies, Inc.	641
Park Systems, Inc.	617
Purdue University	641
SPECS Surface Nano Analysis GmbH.....	676



www.mrs.org/bulletin

MRS members—access *MRS Bulletin* online

www.materialsforenergy.org

Join the conversation in the Materials for Energy blog

www.mrs.org/mymrs

MRS Publications Alert—
 receive advance Table of Contents by email

<http://journals.cambridge.org/mrsbulletin-rss>

Subscribe TODAY to the *MRS Bulletin* RSS Feed

About the Materials Research Society

The Materials Research Society (MRS), a not-for-profit scientific association founded in 1973, promotes interdisciplinary goal-oriented basic research on materials of technological importance. Membership in the Society includes almost 16,000 scientists, engineers, and research managers from industrial, government, and university research laboratories in the United States and over 80 countries.

The Society's interdisciplinary approach differs from that of single-discipline professional societies because it promotes information exchange across the many technical fields touching materials development. MRS sponsors three major international annual meetings encompassing approximately 125 topical symposia, and also sponsors numerous single-topic scientific meetings. The Society recognizes professional and technical excellence and fosters technical interaction in local geographic regions through Sections and University Chapters.

MRS participates in the international arena of materials research through the International Union of Materials Research Societies (IUMRS). MRS is a member of the Alliance for Science & Technology Research in America and is an affiliate of the American Institute of Physics.

MRS publishes The MRS Online Proceedings Library, *MRS Bulletin*, *Journal of Materials Research*, *MRS Communications*, and other publications related to current research activities.

2012 MRS BOARD OF DIRECTORS

President Bruce M. Clemens, Stanford University, USA
Immediate Past President James J. De Yoreo, Lawrence Berkeley National Laboratory, USA
Vice President and President-Elect Orlando Auciello, Argonne National Laboratory, USA
Secretary Sean J. Hearne, Sandia National Laboratories, USA
Treasurer Michael R. Fitzsimmons, Los Alamos National Laboratory, USA
Executive Director Todd M. Osman, Materials Research Society, USA

Wade Adams, Rice University, USA
Ana Claudia Arias, University of California–Berkeley, USA
Shenda Baker, Synedgen, Inc./Harvey Mudd College, USA
Tia Benson Tolle, U.S. Air Force Research Laboratory, USA
Duane B. Dimos, Sandia National Laboratories, USA
Chang-Beom Eom, University of Wisconsin–Madison, USA
Eric Garfunkel, Rutgers University, USA
J. Murray Gibson, Argonne National Laboratory, USA
Oliver Kraft, Karlsruhe Institute of Technology, Germany
Hideki Matsumura, Japan Advanced Institute of Science and Technology, Japan
Stephen K. Streiffer, Argonne National Laboratory, USA
James C. Sturm, Princeton University, USA
Susan E. Trolier-McKinstry, The Pennsylvania State University, USA
Pierre Wiltzius, University of California–Santa Barbara, USA

MRS OPERATING COMMITTEE CHAIRS

Academic Affairs M. Stanley Whittingham, SUNY–Binghamton, USA
Awards C. Barry Carter, University of Connecticut, USA
Government Affairs Nabil Bassim, U.S. Naval Research Laboratory, USA
Meetings Committee David S. Ginley, National Renewable Energy Laboratory, USA
Membership Yves Chabal, The University of Texas at Dallas, USA
Public Outreach Aditi Risbud, Lawrence Berkeley National Laboratory, USA
Publications Paul McIntyre, Stanford University, USA

MRS OFFICE OF PUBLIC AFFAIRS

Ron Kelley 499 South Capitol St. SW, Suite 600, Washington, DC 20003

Editor

Gopal R. Rao, rao@mrs.org

Managing Editor

Judy Meiksin, meiksin@mrs.org

Technical Editor

Lori A. Wilson, lwilson@mrs.org

Editorial Assistants

Ben Moriarty, moriarty@mrs.org
Mary Wilmoth

Associate Technical Editor

Carol Tseng

Art Director

Kasia M. Bruniani

Production/Design

Andrea Pekelnicky, Christopher R. Roberts, and TNQ

Production Editor

Catherine Paduani

Science News Editor

Tim Palucka

Principal Development Editor

Elizabeth L. Fleischer

Director of Communications

Eileen Kiley Novak

Guest Editors

Nina Balke, Dawn Bonnell, David S. Ginger, and Martijn Kemerink

Special Consultants

Babu Chalamala and Alan Sellinger

Energy Quarterly

Steve M. Yalisove (Chair), V.S. Arunachalam, Anshu Bharadwaj, David Cahen, Russell R. Chianelli, George Crabtree, Abdellilah Slaoui, Guillermo Solórzano, and M. Stanley Whittingham

Advertising/Sponsorship

Mary E. Kaufold, kaufold@mrs.org
Donna L. Watterson, watterson@mrs.org

Member Subscriptions

Michelle Judt, judt@mrs.org

Non-Member Subscriptions

subscriptions_newyork@cambridge.org

EDITORIAL BOARD

Paul S. Drzaic (Chair), Apple, Inc., USA
V.S. Arunachalam, Center for Study of Science, Technology & Policy, India
Marie-Isabelle Baraton, University of Limoges, France
Robert C. Cammarata, Johns Hopkins University, USA
Laura Fornaro, University of Uruguay, Uruguay
Hanns-Ulrich Habermeier, Max Planck Institute for Solid State Research, Germany
Fiona C. Meldrum, University of Leeds, UK
Amit Misra, Los Alamos National Laboratory, USA
Julie A. Nucci, Cornell University, USA
Linda J. Olafsen, Baylor University, USA
David N. Seidman, Northwestern University, USA
Carol Trager-Cowan, University of Strathclyde, UK
Julia R. Weertman, Northwestern University, USA
Eric Werwa, Washington, DC, USA
Steve M. Yalisove, University of Michigan, USA

VOLUME ORGANIZERS

2013 Mark T. Lusk, Colorado School of Mines, USA
Eva Olsson, Chalmers University of Technology, Sweden
Birgit Schwenzler, Pacific Northwest National Laboratory, USA
James W. Stasiak, Hewlett-Packard Co., USA

2012 Lei Jiang, Chinese Academy of Sciences, China
Sergei V. Kalinin, Oak Ridge National Laboratory, USA
Stéphanie P. Lacour, EPFL, Switzerland
Steven C. Moss, Aerospace Corporation, USA

2011 Kyoung-Shin Choi, Purdue University, USA
Reuben T. Collins, Colorado School of Mines, USA
Sean E. Shaheen, University of Denver, USA

MRS Bulletin (ISSN: 0883-7694, print; ISSN 1938-1425, online) is published 12 times a year by the Materials Research Society, 506 Keystone Drive, Warrendale, PA 15086-7573. Copyright © 2012, Materials Research Society. Permission required to reproduce content. Periodical postage paid at New York, NY, and at additional mailing offices. POSTMASTER: Send address changes to *MRS Bulletin* in care of the Journals Department, Cambridge University Press, 100 Brook Hill Drive, West Nyack, NY 10994-2113, USA. Printed in the U.S.A.

Membership in MRS is \$115 annually for regular members, \$30 for students. Dues include an allocation of \$29 (\$17 for students) to a subscription to *MRS Bulletin*. Individual member subscriptions are for personal use only. Non-member subscription rates are \$363 for one calendar year (12 issues) within North America and \$436 elsewhere. Requests from subscribers for missing journal issues will be honored without charge only if received within six months of the issue's actual date of publication.

MRS Bulletin is included in Current Contents®/Engineering, Computing, and Technology; Current Contents®/Physical, Chemical, and Earth Sciences, the SciSearch® online database, Research Alert®, Science Citation Index®, and the Materials Science Citation Index™. Back volumes of *MRS Bulletin* are available on microfiche through University Microfilms Inc., 300 North Zeeb Road, Ann Arbor, MI 48106, USA.

Send Letters to the Editor to **Bulletin@mrs.org**. Include your name, affiliation, and full contact information.