

FAR ULTRAVIOLET EXCITATION PROCESSES IN COMETS

P. D. Feldman, C. B. Opal, R. R. Meier and K. R. Nicolas

Introduction

The recent observations of atomic oxygen and carbon in the far ultraviolet spectrum of Comet Kohoutek (1973f) (Feldman *et al.* 1974; Opal *et al.* 1974) have demonstrated the existence of these atomic species in the cometary coma. However, in order to identify the source of their origin, it is necessary to relate the observed ultraviolet flux to the atomic production rate. Assuming the only excitation mechanisms allowed are those produced by resonance scattering and fluorescence of solar ultraviolet radiation, the problem reduces to finding the emission rate factors (g-factors) as a function of the heliocentric comet velocity. Since the widths of the solar emission lines are smaller than the maximum heliocentric Doppler shift, given by

$$v_{\text{max}} = \left(\frac{M_{\odot} G}{q} \right)^{1/2} = 21.06 q^{-1/2} \text{ km sec}^{-1},$$

where q is the perihelion distance in A.U., it is necessary to consider the detailed multiplet structure of the transition, the solar line shape and the relaxation of excited fine structure levels.

Analyses of the observed OI $\lambda 1304$ and CI $\lambda 1657$ A multiplets have been carried out using high resolution solar spectra obtained from the ATM solar spectrograph aboard Skylab. In addition, we have examined the possibility of observing ultraviolet fluorescence from molecules such as CO (which may be the parent molecule of atomic carbon) and H_2 , as well as resonance scattering either from atomic ions² for which there are strong corresponding solar lines (CII) or from atoms for which there is an accidental wavelength coincidence (SI). The scattering of solar Ly α from atomic hydrogen has been discussed in detail by Keller (1973) and Meier (1974) and will not be considered here.

Emission Rate Factor

The emission rate factor, which is the probability that an atom or molecule will resonantly scatter a solar photon of wavelength λ into 4π sr in unit time, is given by Barth (1969) as:

$$g_{\lambda} = \left(\frac{\pi e^2}{2mc} \right) \lambda^2 f_{\lambda} (\pi F_{\lambda}) \text{ photons sec}^{-1} \text{ mol}^{-1}$$

where f_{λ} is the absorption oscillator strength and πF_{λ}

the solar flux per unit wavelength. For resonance fluorescence in molecules, the relative transition probabilities for downward transitions must also be taken into account. The emission rate per unit volume is then simply related to the density of the scattering species n_i by

$$j_\lambda = g_\lambda n_i \text{ photons sec}^{-1} \text{ cm}^{-3}$$

In the case of cometary emission, the large heliocentric velocity of a typical comet requires the use of the solar flux $\pi F_{\lambda'}$, where

$$\lambda' = \lambda \left(1 - \frac{\dot{r}}{c}\right),$$

so that $g_\lambda = g_\lambda(\dot{r}) = g_\lambda(r, q)$.

Solar Ultraviolet Fluxes

The Naval Research Laboratory solar spectrograph (S082B) on the Apollo Telescope Mount (ATM) of Skylab photographed the solar spectrum from 970 Å - 4000 Å. It provided the necessary high spectral resolution (0.06 Å) to yield data necessary for the cometary interpretation. The spectrograph slit averaged over a 2" by 60" area on the sun. In order to estimate the solar intensity from the total disk it was necessary to include the effects from limb brightening and from the increased contribution of active regions which introduces a variable intensity component. Spectra of these phenomena were available from the large number of observations taken within the Joint Observing Program.

Densitometry of the Kodak 104 film gave the density versus position information which was used to determine the relative intensity versus wavelength of the solar spectrum. Spectra with 40, 160, and 640 sec exposure times were used to construct a relative H-D curve for each wavelength region of interest. The conversion from density to relative intensity for each of the plates in the exposure sequences yielded a maximum variation in relative line shape of about $\pm 15\%$, the random error being mostly due to grain clumping. The wavelength determination was made by using from 5 to 9 standard lines (Sandlin, 1974) within each wavelength interval. The estimated absolute error is ± 0.02 Å which translates into

$\pm 10\%$ intensity error at the steepest part of the line profile.

The absolute intensity was determined independently of the ATM calibration in two ways.* The first method was to match the continuum intensity level at 1650 Å with a value determined from a 1971 rocket flight (Brueckner and Nicolas, 1972). This gave an absolute intensity scale for the CI emission feature at 1656 Å. The rms error is about $\pm 30\%$. At shorter wavelengths the absolute scale was determined by comparing the total relative line intensities with those of OSO VI (Dupree et al. 1973). The error for this method is approximately $\pm 100\%$, -50% .

The total flux averaged over the solar surface and its time variation was estimated from spectra of quiet solar limb scans and of active regions. The intensity of the emission lines is fairly constant (neutral) over the solar disk. The maximum error introduced by assuming that they have neutral limb brightening is less than $\pm 10\%$. The active region enhancement over the quiet region intensity is approximately a factor of 2 to 3 for CI and a factor of 10 to 20 for OI and CII. Since the area of the disk covered by active regions can be as high as 10% (De Jager 1961), the total solar flux during the solar cycle could vary by 30% for CI and up to a factor of 2 to 3 for OI or CII. Short term fluctuations (on the order of two weeks) within a solar cycle could also be of comparable magnitude.

CI $\lambda 1657$ Å

The carbon multiplet at 1657 Å provides an excellent example of the dependence of g_λ on radial velocity. Carbon, long known as a major constituent of cometary molecules and radicals, was not detected in atomic form until the two recent rocket ultraviolet observations of Comet Kohoutek. There are six components of the multiplet, as shown in Fig. 1, resulting from the fine structure triplet nature of both the excited and ground state. An additional consideration in the evaluation of the g -factors in cometary emission is the question of relative population of ground state fine structure levels. We assume that they are initially populated according to a Boltzmann distribution characteristic of some temperature T_0 of the parent molecule. However, since the coma becomes non-collisional very close to the nucleus, radiative transitions $J=2 \rightarrow J=1$ and $J=1 \rightarrow J=0$ will tend to cool the atom in a time of the

*The inflight ATM calibration is not yet finished, but will be completed and published shortly.

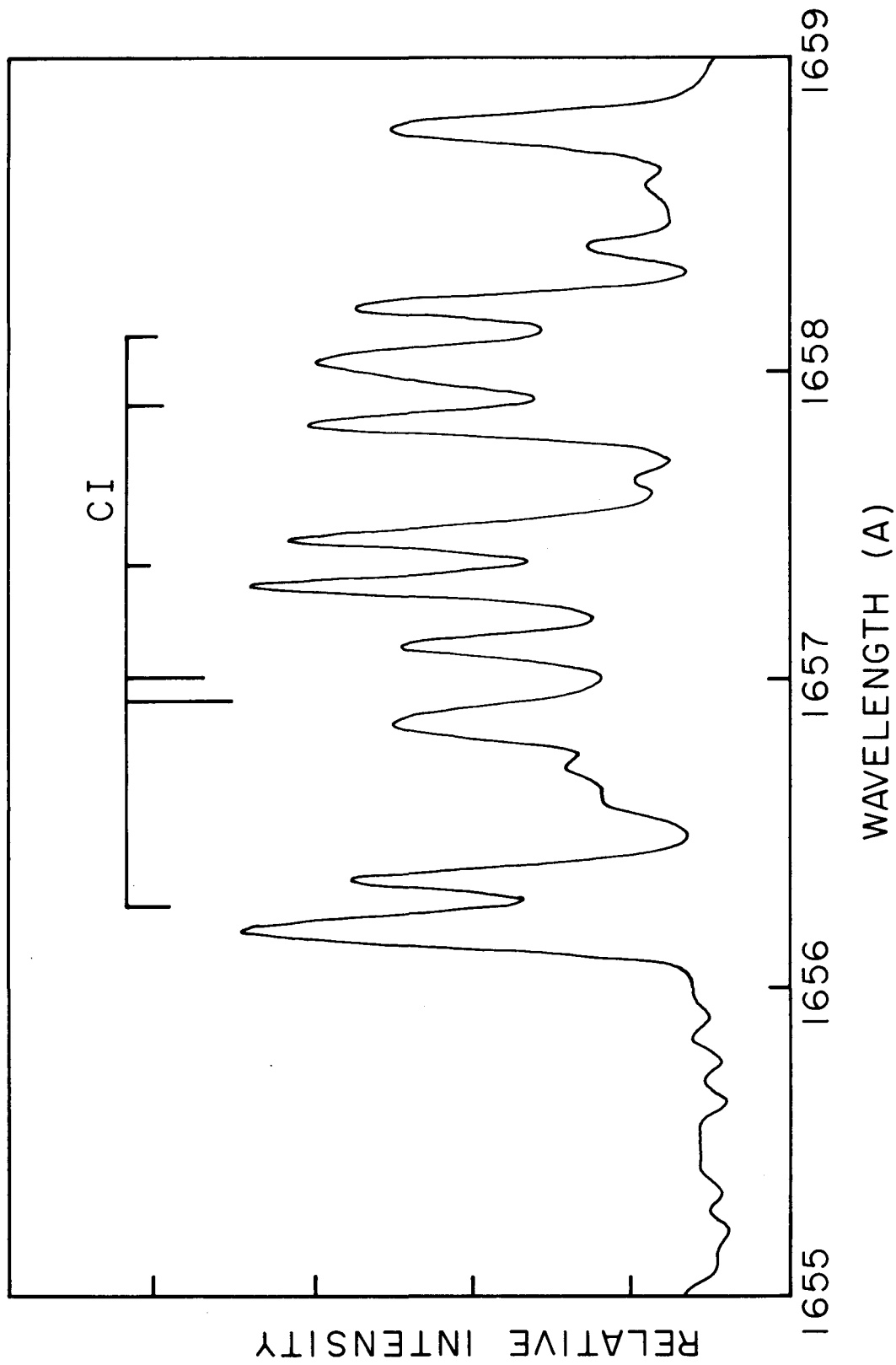

Fig. 1. High resolution spectrum ($\Delta\lambda = 0.06 \text{ \AA}$) of the sun in the region of the CI multiplet at 1657 Å, observed 300" in from the solar limb.

order $\tau_c = A_{ij}^{-1}$, where A_{ij} is the Einstein coefficient for the transition. The effect of cooling is significant only if the A_{ij} values are greater than the photoionization rate J_i which depends on heliocentric distance as r^{-2} . For the carbon ground state, $A_{10} = 7.9 \times 10^{-8} \text{ sec}^{-1}$ and $A_{21} = 2.7 \times 10^{-7} \text{ sec}^{-1}$, which are both less than the value of J_i at 1 A.U. of $4.0 \times 10^{-6} \text{ sec}^{-1}$ (Feldman *et al.* 1974). The distance at which the cooling time τ_c and ionization lifetime τ_i are equal, r_c , is given in Table I for the most important species. For cases in which $\tau_c < \tau_i$ the variation of the relative populations in time will be determined primarily by the effect of optical pumping produced by the resonance scattering of solar radiation, which as we have noted will also vary with both r and \dot{r} . In most cases of interest, the resonance scattering time, $\tau_s = g_\lambda^{-1}$, is less than τ_c , so that the optical pumping effect is not negligible.

To first order we regard the temperature in the coma as constant and show in Figs. 2 and 3 the variation of g_λ with r and \dot{r} . All g -factors are calculated for $r = 1 \text{ A.U.}$ The values of r corresponding to the observations of Comet Kohoutek are indicated in Fig. 3. For planetary atmospheres the value of g for $r = 0$ is to be used.

OI $\lambda 1304 \text{ \AA}$

The oxygen triplet in the solar spectrum has recently been observed with sufficient resolution to permit the evaluation of the absorption at the line center due to terrestrial oxygen in the upper atmosphere. An example of one of the lines (after correction for atmospheric absorption) is shown in Fig. 4. A Doppler shift of $\pm 0.17 \text{ \AA}$ corresponding to a velocity of $\pm 40 \text{ km sec}^{-1}$ is sufficient to completely shift the cometary absorption wavelength completely off of the solar line. Thus the observed oxygen emission (Feldman *et al.* 1974; Opal *et al.* 1974) must be due to either resonance scattering from the solar continuum, which is very weak, or another mechanism. Fig. 5 illustrates a Bowen fluorescence mechanism in which the 3S_1 state is populated via the $^3D-^3P$ transition at 1025.77 \AA which is nearly degenerate with the solar Ly β line of HI at 1025.72 \AA . The g -factors for the entire multiplet for the two processes are illustrated in Fig. 4. Resonance scattering from the solar continuum gives a g -factor of $4 \times 10^{-8} \text{ sec}^{-1} \text{ atom}^{-1}$, independent of wavelength. For the case of oxygen, cooling via the fine structure transitions at

Table I

COOLING AND IONIZATION TIMES

<u>Species</u>	<u>τ_c (sec)</u>	<u>τ_i (sec at 1 A.U.)</u>	<u>r_c (A.U.)</u>
OI	10^4	4.0×10^6	0.05
CI	10^7	2.5×10^5	6.3
CII	4×10^5	--	--

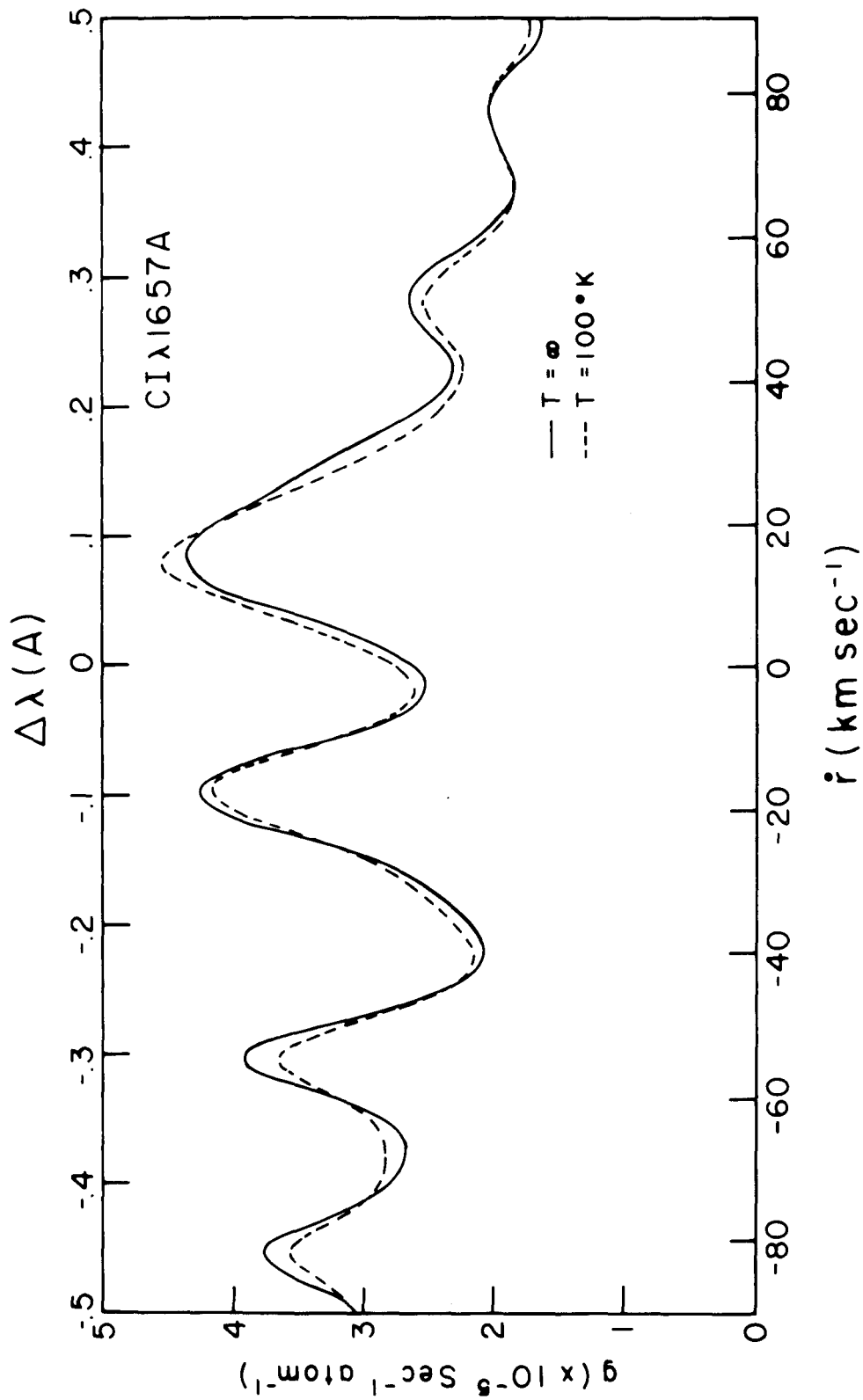

Fig. 2. Dependence of the CI 1657 A g-factor on heliocentric velocity.

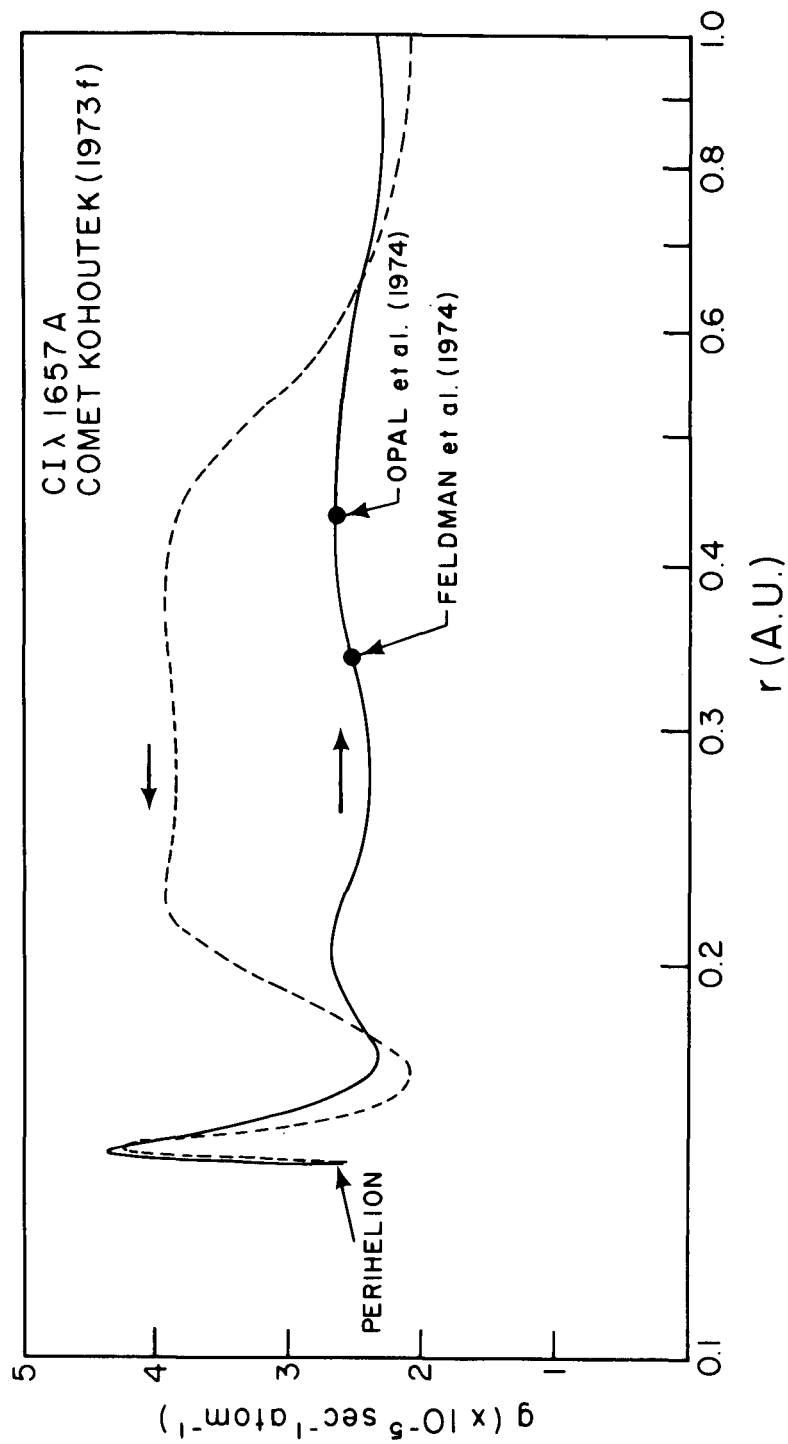

Fig. 3. Dependence of the CI 1657 A g-factor on heliocentric distance for Comet Kohoutek (1973f). The arrows indicate direction of motion.

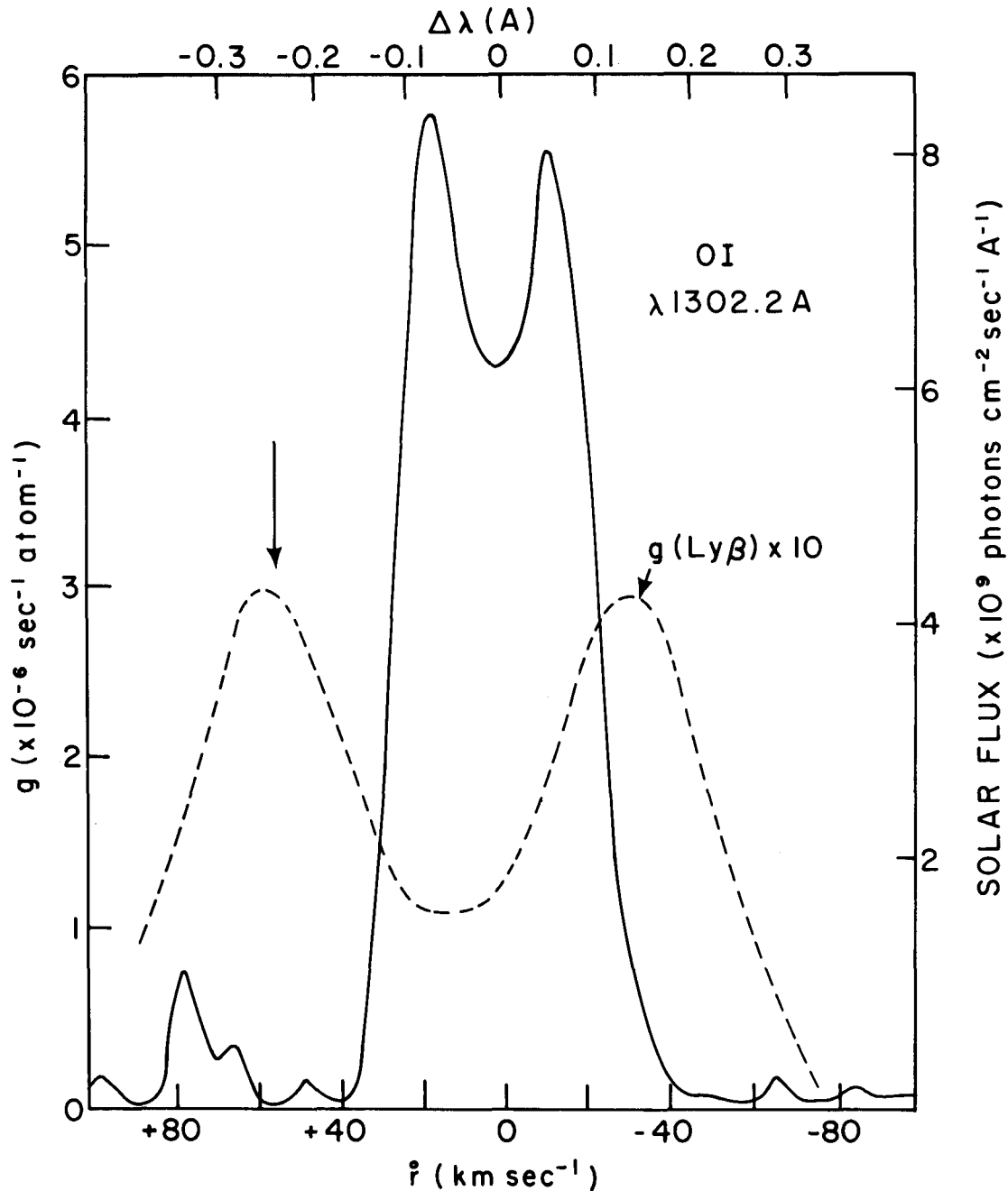

Fig. 4. High resolution profile of the solar O I 1302.2 Å line. The O I g-factor is shown for both resonance scattering and fluorescence excited by solar Ly β as a function of heliocentric velocity. The arrows correspond to the observations of Feldman *et al.* (1974) and Opal *et al.* (1974).

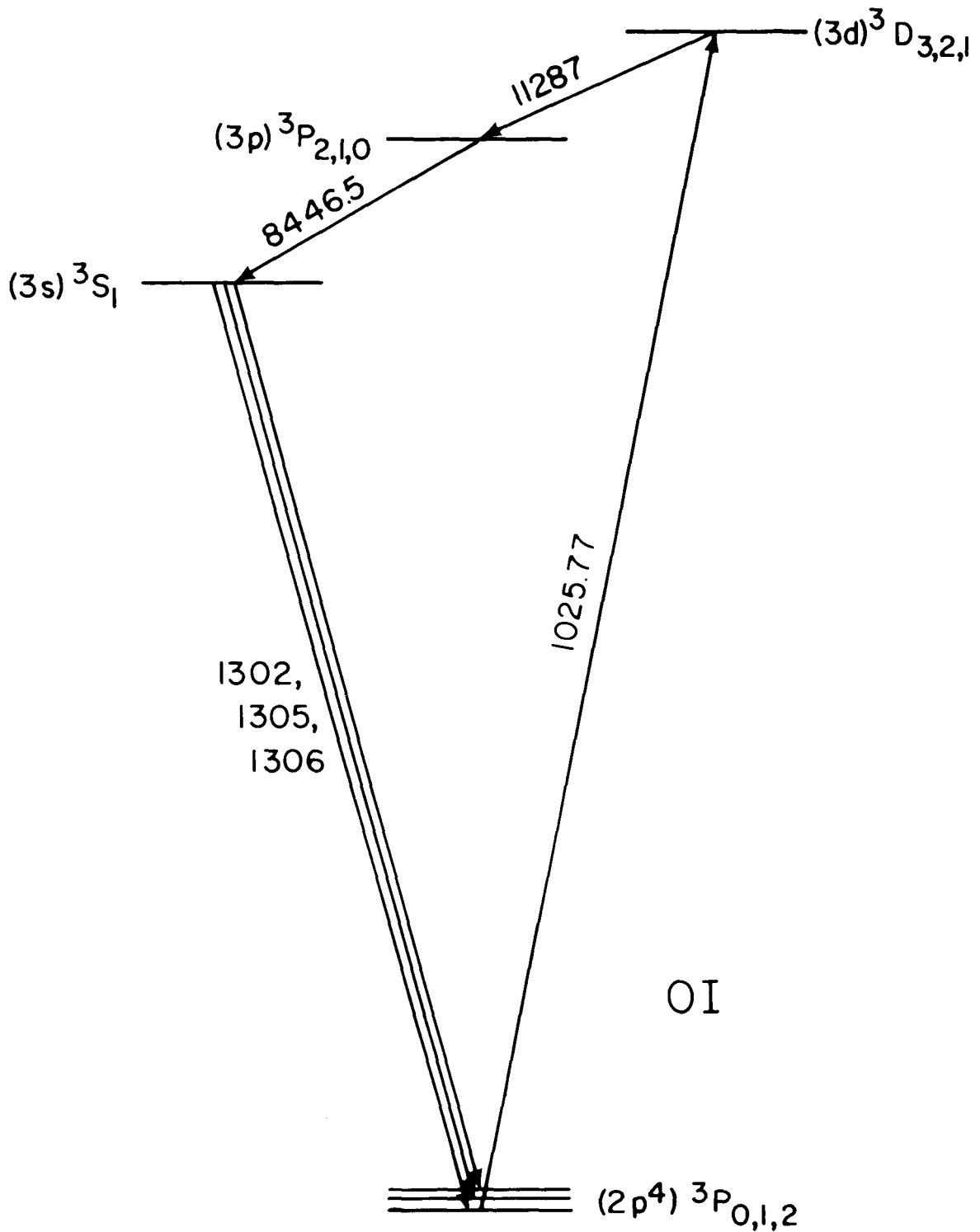

Fig. 5. Fluorescence mechanism for excitation of OI 1302 Å via solar Ly β radiation.

63 μ and 147 μ is quite rapid with $\tau_c < \tau_i, \tau_s$. However, for any reasonable range of equivalent temperatures, since the individual lines do not overlap, there is little variation in the total multiplet intensity. For the Bowen mechanism we assume that all of the atoms are in the lowest (J=2) level.

While the intensity due to Bowen fluorescence is more than an order of magnitude smaller than that due to direct resonance scattering, for comet velocities $>40 \text{ km sec}^{-1}$ it is the dominant source of cometary $\lambda 1304$ emission. Using the Bowen g-factor, the oxygen production rate derived by Feldman *et al.* (1974) for Comet Kohoutek on 5.1 January 1974 was found to satisfy the requirement $Q_O = Q_{OH} = 1/2 Q_H = Q_{H_2O}$ expected if photodissociation of water is the dominant source of atomic oxygen. At smaller heliocentric velocities the comet might be expected to be extremely bright at 1304 A and in fact could provide, near perihelion, a measurement of the solar 1304 A multiplet profile free of the effects of terrestrial oxygen absorption since the cometary absorption width is small compared with the width of the solar emission profile. The role of photoelectron excitation has been neglected since it is assumed that the coma becomes collisionless at radii greater than $\approx 10^4 \text{ km}$ in which case the 1304 A image would appear to be less than 1 minute of arc contrary to the 10 arc min image reported by Opal *et al.* (1974).

Because of the steep slope in the solar line shape, corresponding to Doppler velocities of the order of $\pm 25 \text{ km sec}^{-1}$, an appreciable intensity asymmetry (Greenstein, 1958) can result. To illustrate the effect of a rapidly varying solar line profile, we have computed atomic oxygen 1304 A intensities from Comet Kohoutek under somewhat idealized conditions. For resonance scattering, one must compute the probability that a photon of a given frequency and direction (from the sun) will be scattered at a new frequency in the direction of the observer. The procedure for doing this is described by Meier (1974). At each point in the atmosphere this probability function must be integrated over the solar line, the velocity distribution of oxygen, and the emitted line profile. The resulting volume emission rate must then be integrated along the line of sight to compute the column emission rate. Assuming a radial outflow density distribution and a radial maxwell-Boltzmann velocity distribution (Keller, 1973; Bertaux *et al.*, 1973), we have computed the expected Greenstein effect. The idealized observation for the comet is taken to be at a 90° sun-comet-earth angle. Velocities of 0 and $-22.5 \text{ km sec}^{-1}$ relative to

the sun are used. The mean velocity of oxygen atoms is taken to be 1 and 2 km sec⁻¹ both with a production rate of 10²⁸ atoms sec⁻¹ sr⁻¹ and a g-factor appropriate to 1 A.U. The solar line shape in Fig. 4 was used. The line-center point of the comet rest frame is at $r=0$ in Fig. 4. As discussed above, all atoms are assumed to be in the ground state so that although only the 1302.2 Å line participates in excitation, all three lines will be present in emission.

The results of this calculation are shown in Fig. 6. The larger asymmetry found for the 2 km sec⁻¹ outflow velocity is due to the broader cometary absorption coefficient overlapping a larger portion of the solar line. The $r = -22.5$ km sec⁻¹ isophotes have both been normalized to the $r = 0$ case (a factor of 1.275) for purposes of comparison in the figure. Thus it is clear that the degree of asymmetry upsun and downsun can yield information about the mean velocity of the scattering gas when the solar line varies significantly over the absorption line.

CII λ 1335 Å

An anti-solar tail at least 5×10^6 km long and about 5×10^5 km wide was observed in the 1250-1800 Å band before perihelion at $r = .182$ A.U. with the electrographic camera on Skylab 4 (Page, 1974). This feature should also have been observable by the rocket instruments, assuming an r^{-4} power law dependence of brightness on sun-comet distance, however the rocket images in that band of Opal *et al.* (1974) showed only a circular coma, attributed mainly to 1304 Å oxygen emission, and the spectrometer of Feldman *et al.* (1974) observed down-sun of the comet for over 30 sec without detecting any emissions from the comet.

The tail observed from Skylab could be attributed to dust, a neutral species, or an ion. The dust tail hypothesis can probably be ruled out from geometrical considerations, but in any case it should have been observed by the more sensitive rocket instruments. For a neutral constituent to form the tail, it would have to be strongly influenced by radiation pressure yet have a very long lifetime, which is highly improbable at such a small sun-comet distance. The remaining candidate is an ion, with C⁺ as the obvious choice, since it has a resonance multiplet in the bandpass (1335 Å) and the sun

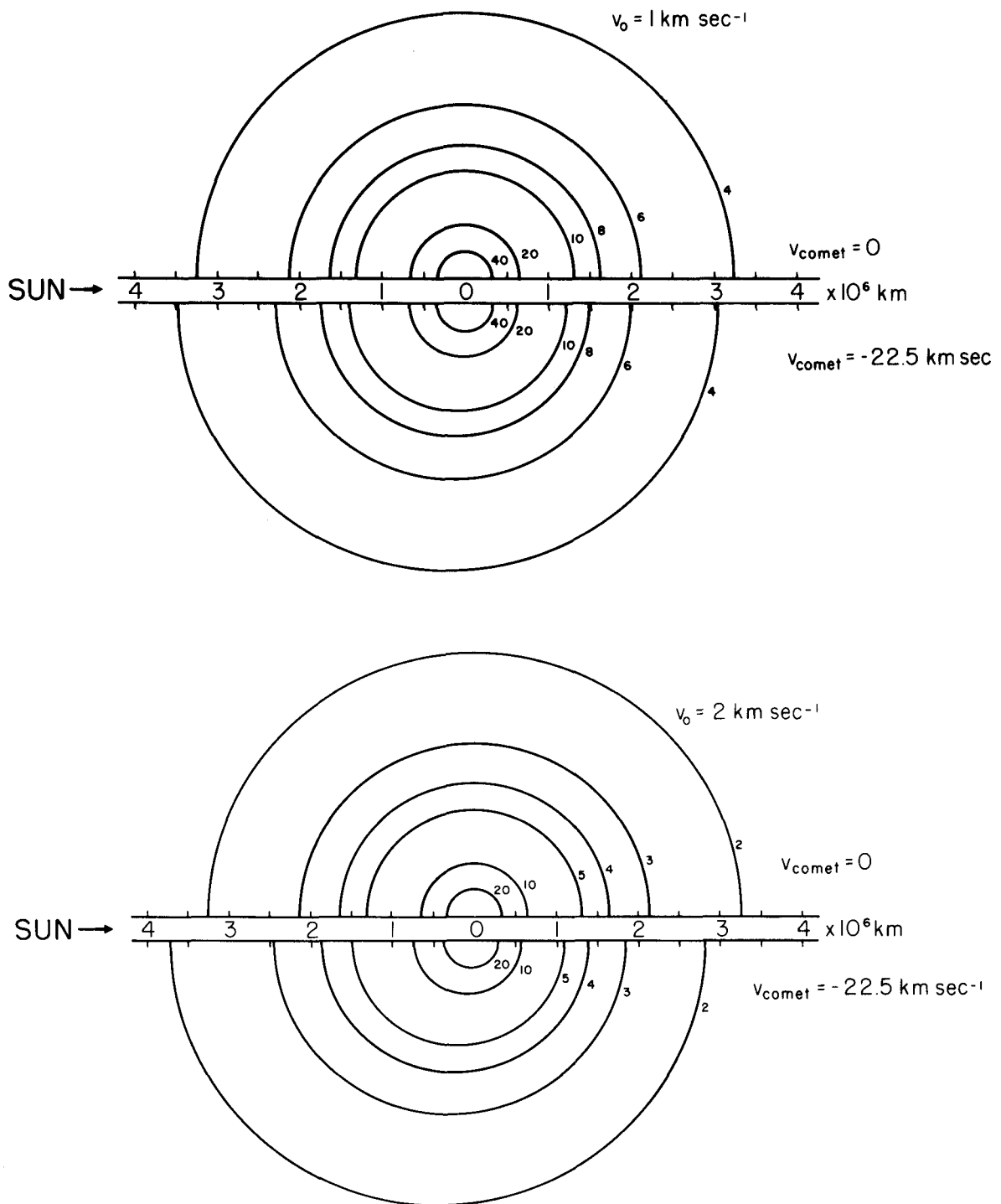

Fig. 6. Intensity contours for OI 1304 A computed for heliocentric velocities of 0 and $-22.5 \text{ km sec}^{-1}$. The outflow velocity of oxygen atoms is 1 km sec^{-1} in (a) and 2 km sec^{-1} in (b).

emits the multiplet strongly. The fact that no ion tail was observed from the rockets after perihelion is explained by considering the motion of an ion created in a moving plasma. In the rest frame of a (perfectly conducting) plasma there is only a magnetic field, so the ion velocity consists of its original component parallel to the field plus a circular component due to its orbit around the field line. In the frame of the sun, the radial velocity of the ion will then consist of the sum of the radial velocity of the comet and a cycloidal component varying between zero and twice the radial plasma velocity (which can be as much as 10^3 km sec^{-1} outward if the ion is in the solar wind). Thus before perihelion the ions spend considerable time with a small radial velocity and can resonantly scatter the solar line. After perihelion the radial velocity of the ions can never be less than that of the comet, so at the time of the rocket observations, when the ions were always Doppler shifted completely out of the solar lines, the ionized carbon was unobservable.

CO Fourth Positive System

Fluorescence of CO in the fourth positive system ($A^1\pi - X^1\Sigma^+$) can be excited by solar radiation shortward of 1544 Å. The g factors for the strongest bands are shown in Fig. 7, using oscillator strengths and branching ratios given by Mumma *et al.* (1971) and the continuum solar flux of Rottman (private communication; see Donnelly and Pope 1973). Since excitation is from the continuum there is no variation in the g -factors with r . The g -factor for the total fourth positive emission between 1440 and 1670 Å is simply the sum of all of the values shown in Fig. 7, 1.24×10^{-6} photons $\text{sec}^{-1} \text{mol}^{-1}$. The flux at the earth can be written as

$$F = \frac{Q \cdot g^{\tau}}{4\pi \Delta^2}$$

where Q is the production rate in molecules sec^{-1} and the product g^{τ} is independent of heliocentric distance and may conveniently be evaluated at 1 A.U. In Table II we give the values of g and τ for C, O and CO at the time of the rocket observations of Comet Kohoutek. If CO were in fact the parent of the observed carbon we would expect $Q_C = Q_O \approx \frac{1}{2} Q_{CO}$, since the CO photodissociation

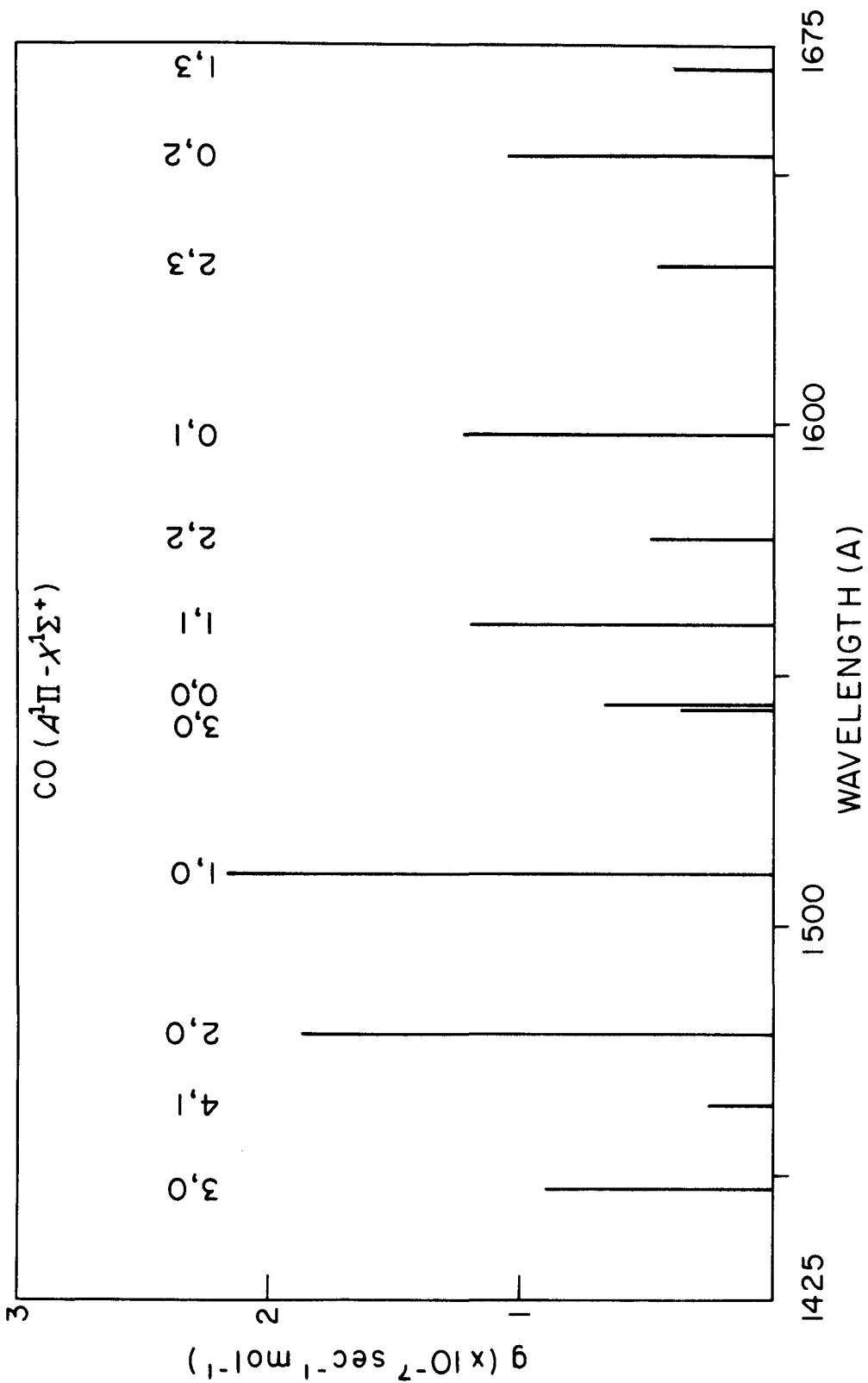

Fig. 7. g-factors for the strongest bands of the CO fourth positive system.

Table II

Excitation Parameters for $\dot{r} = +55 \text{ km sec}^{-1}$

<u>Species</u>	$\frac{g}{\text{photons sec}^{-1} \text{ mol}^{-1}}$	$\frac{\tau}{\text{(sec)}}$	$\frac{g\tau}{\text{(photons mol}^{-1}\text{)}}$	<u>Relative Signal</u>
CI λ 1657 A	2.5×10^{-5}	2.5×10^5	6.25	.49
OI λ 1304 A	3.4×10^{-7}	4.0×10^6	1.36	.28
CO (1440-1670 A)	1.2×10^{-6}	6.9×10^5	0.86	.23

(McElroy and McConnell 1971) and photoionization (Siscoe and Mukherjee 1972) rates are nearly equal. The table also gives the relative signal to be expected in this case, taking into account the response of a CsI photocathode, and it is seen that the three constituents give comparable contributions to the signal. Of course the primary source of oxygen, the photodissociation of OH, will give a larger 1304 Å signal.

It should be noted that detection of the strongest CO bands was just beyond the sensitivity of both rocket instruments, but that an order of magnitude improvement in either the instrument capability or the brightness of the comet at the time of observation would have enabled us to determine whether or not CO is the parent molecule. The values of Q_i derived from the data of Feldman *et al.* (1974) have been revised using the g -factor discussed above, and are given in Table III. The upper limit on Q_{CO} is about a factor of 3 higher than would be expected from the derived Q_C .

The (9, 0) fourth positive band at 1301 Å is nearly coincident with the OI line at 1302.17 Å, raising the possibility of strong fluorescence in the $v' = 9$ progression. However, the absorption oscillator strength is smaller than that for the (1, 0) band by roughly the same amount that the solar flux in the line is greater than the continuum at 1510 Å so that the absorption g -factors are of comparable magnitude. The rotational development of the band extends several Å so that the overlap of the band with the relatively narrow OI line is less than 10%, as shown in Fig. 8 for $T = 100^\circ\text{K}$. The maximum g -factor obtainable for any one band in this progression is $< 1.0 \times 10^{-8}$ which is considerably smaller than the values given in Fig. 7. A plot of the g -factor for the (9, 2) band at 1378 Å as a function of r is shown in Fig. 9.

H₂ Lyman Band System

Solar HI Ly β can also produce fluorescence in the $v' = 6$ progression of the Lyman band system of H₂ with the strongest emission in the (6, 13) band at 1608 Å (Feldman and Fastie 1973). The P1 line lies at 1025.935 Å while the wavelength of the Ly β line center is at 1025.72 Å, so that once again the g -factor is a sensitive function of r . The dependence on r is the same as the dashed curve in Fig. 4, except that the velocity axis is shifted so that the peak g -factors occur at values of

Table III

SUMMARY OF RESULTS FROM AEROBEE 26. 023

<u>Species</u>	$\frac{F}{\text{photons sec}^{-1} \text{ cm}^{-2}}$	$\frac{g}{\text{sec}^{-1} \text{ mol}^{-1}}$	$\frac{\tau}{\text{(sec)}}$	$\frac{Q}{\text{(sec}^{-1}\text{)}}$
OI 1304 A	120 ± 40	3.4×10^{-7}	4.0×10^6	2.1×10^{29}
CI 1657 A	140 ± 50	2.5×10^{-5}	2.5×10^5	0.5×10^{29}
OH 3090 A (0, 0)	3100 ± 100	1.2×10^{-3}	1.0×10^5	0.6×10^{29}
CO 1510 A (1, 0)	≤ 15	2.2×10^{-7}	6.9×10^5	$\leq 2.7 \times 10^{29}$

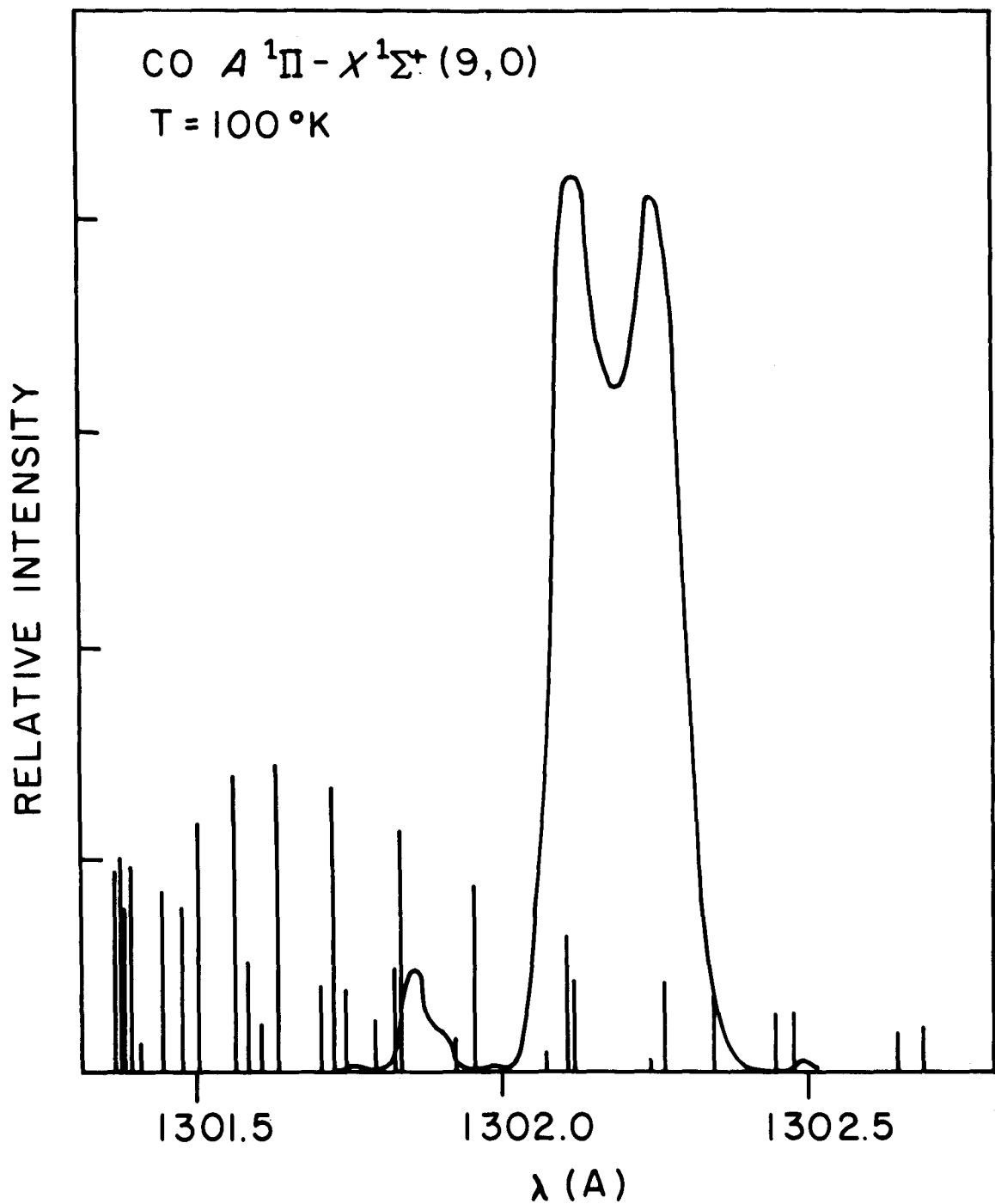

Fig. 8. Line strengths in the (9, 0) band of the CO fourth positive system showing the overlap with the solar OI 1203 Å line.

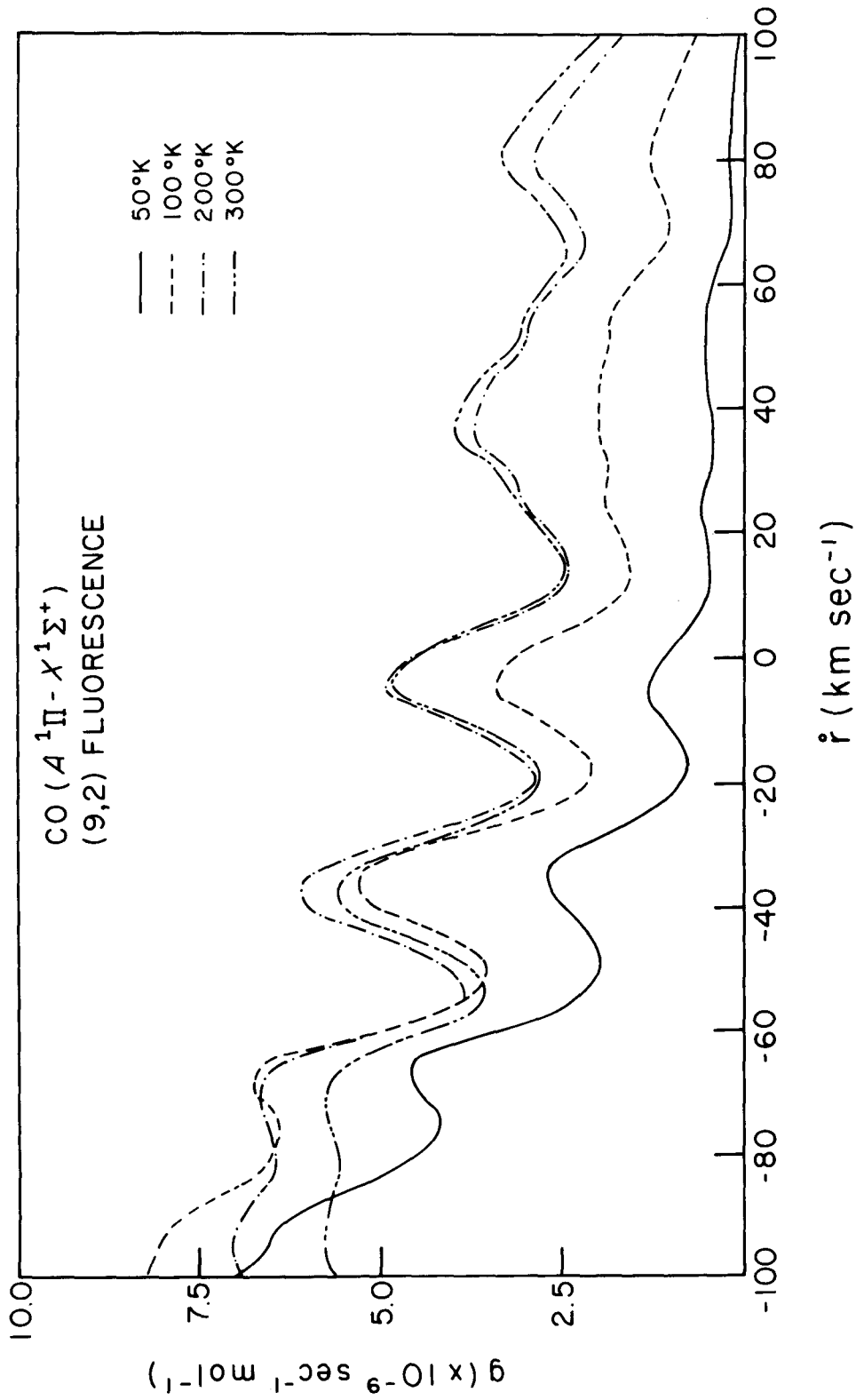

Fig. 9. Expected fluorescence in the (9, 2) band due to the overlap with the solar OI 1302 Å line.

\dot{r} of +15 and +110 km sec⁻¹. In this case, significant observations can be made only in the post-perihelion period. The maximum g-factor for the (6, 13) band is temperature dependent and has a value of 1.6×10^{-7} sec⁻¹ mol⁻¹ for T = 300°K at 1 A.U. Using this value, the data of Feldman *et al.* (1974) give an upper limit to the H₂ production rate an order of magnitude smaller than the production rate of atomic hydrogen.

SI λ 1300 A

Finally, we consider the possibility of an accidental coincidence between a strong solar emission line and the resonance transition of a minor species. For example the sulfur multiplet near 1300 A contains a ³P₁ - ³P₂ line at 1302.34 which can resonantly scatter the OI 1302.17 A line over a wide range of heliocentric velocities. For this particular sulfur line the cooling time of the J=1 level is short ($\approx 10^3$ sec), so that resonance scattering from it is highly unlikely. However, in the general case of wavelength coincidence, the identity of the scattering species would have to be determined either by means of high resolution spectroscopy or from a measurement of intensity over a large range of values of \dot{r} . No unidentifiable features were found with either of the rocket spectrometers.

Future Observations

At present, the major uncertainty in the interpretation of cometary ultraviolet emission features lies in the value of the species lifetime. Many authors have evaluated photoionization and photodissociation lifetimes, but these are based largely on theoretical cross-sections. In addition, the effect of solar wind ionization is not understood since the extent of solar wind penetration into the coma is unknown. Photographs of the cometary coma in monochromatic ultraviolet radiation, similar to the Ly α photographs of Opal *et al.* (1974), if obtained at high enough angular resolution, should provide reliable values of the scale length and consequently of these lifetimes. Taken together with ultraviolet spectrophotometric observations of the species discussed above over a large range of heliocentric velocities and distances (presumably from an earth orbiting satellite), it should be possible to determine accurately both the total gas production rate in the comet and its dependence on heliocentric distance.

Acknowledgements

We thank Dr. R. Tousey and the NRL ATM Skylab team for permission to use the ATM results prior to publication. Mr. H. Park assisted in the calculations. The work at Johns Hopkins University was supported by NASA grant NGR-21-001-001.

References

- Barth, C. A., 1969, Appl. Opt., 8, 1295.
- Bertaux, J. L., Blamont, J. E., and Festou, M., 1973, Astron. Astrophys., 25, 415.
- Brueckner, G. E., and Nicolas, K. R., 1972, Bull. A. A. S., 4, 378.
- De Jager, C., 1961, in Vistas in Astronomy, Vol. 4 (Ed. A. Beer; London, Pergamon Press), p. 143.
- Donnelly, R. F., and Pope, J. H., 1973, NOAA Rept. ERL 276-SEL 25.
- Dupree, A. K., Huber, M. C. E., Noyes, R. W., Parkinson, W. H., Reeves, E. M., and Withbroe, G. L., 1973, Ap. J., 182, 321.
- Feldman, P. D., and Fastie, W. G., 1973, Ap. J. (Letters), 185, L101.
- Feldman, P. D., Takacs, P. Z., Fastie, W. G., and Donn, B., 1974, Science, 185, 705.
- Greenstein, J. L., 1958, Ap. J., 128, 106.
- Keller, H. U., 1973, Astron. Astrophys., 23, 269.
- McElroy, M. B., and McConnell, J. C., 1971, J. Geophys. Res., 76, 6674.
- Meier, R. R., 1974, in preparation.
- Mumma, M. J., Stone, E. J., and Zipf, E. C., 1971, J. Chem. Phys., 54, 2627.
- Opal, C. B., Carruthers, G. R., Prinz, D. K., and Meier, R. R., 1974, Science, 185, 702.
- Page, T., 1974, paper presented at Comet Kohoutek workshop, Huntsville, Ala., June 1974.
- Sandlin, G., 1974, private communication.
- Siscoe, G. L., and Mukherjee, N. R., 1972, J. Geophys. Res., 77, 6042.

DISCUSSION

Voice: I just want to know if the values for production rates supersede the ones published in Science.

P. D. Feldman: Yes. They will appear in the proceedings of this conference. I don't think they are going to change. At least, we are not going to do any more work on it.

I think what is called for now are some more observations.